

FURNITURE FITTINGS

Price list 2022
excl. VAT



ACCESSOIRES DE POSE
SISTEMA DE INSTALACION
KUNSTSTOFFBESCHLÄGE



SOMMAIRE

1	NOVELTIES	Self-stick angle profile + dooblocker + Decover
2	MULTITASCING SHOVEL + little wedges	The second hand on the builing site
3	SYSTEMCAL SPRING	Spring frame packers
4	SYSTEMCAL SOLO	Single fitting wedges
5	SYSTEMCAL FITTING	Fitting wedges with folding principle
6	SYSTEMCAL WINDOW	Plastic flat packers
7	SYSTEMCAL HEAVY LOAD	Plastic flat packers for heavy load
8	KDS	Sawtooth spacers
9	BLOCFIX, KDFIX + CLIPS TERRACE	Wedges great distance + outside fitting
10	SILNET + PASSE SYSTEM	Spatulas and universal key
11	GLIDING FEET	Range for all supports
12-13	SYSTEMCACH + DECOVER	Adhesive covers for holes and screws
14	NUT COVER + WASHER...	Accessories for finishing
15	FIXTAB	Shelf supports
16	INCLINOFIX + SYSTEMFIX	Sloped ceiling bracket and height reducer
17	SYSTEMTAC PRO	Full range for professionals
18-19	SYSTEMTAC 2000	Assembling brackets
20	POLYTAC	New range of panel connections
21	RILITAC + HINGE	Temporary fastening and plastic hinge
22	SYSTEMTAC CLASSIC	Corners with integrated cover
23	SYSTEMTAC BASIC + 179	The economic corner range
24	SYSTEMTAC 118, 120, 122, 124	Compact assembling
25	PASSE-FILS + TACFILS	Cabe management
26	SYSTEMTAC 190, 197, TABLE WEDGES	Different accessories
27	SYSTEMTAC 202, 195, 170	Various connection possibilities
28	S.C.P. 32 + SYSTEM 32	Fitting system without tool
29	SYSTEMTAC M + PLINTH SEALING	Fitting bracket 2 en 1 and corne reinforcement
30	RIVCOLOR	Edging profiles
31	CONNECTING PANELS	Profiles for special function
32	PROFILE PVC	Symetric angle profile
33	PROFILE PVC	Asymetric angle profile
34	LABEL HOLDER	Adhesives label holders
35	RIVTIQUETTE	Edging profile with integrated label holder
36	KEY LABELS	Identification for keys
37	TAC'BOULE + SLIDING DOOR HANDLES	Decorative supports for shelves
38-39	SILENTAC	Adhesive bumpers
40-41	INSERT AND FEET	Finition pour tubes
42	FURNITURE FEET	Complete range for hight adjustment
43	VENTILBAIE + TACOPLAC	Retainer for windows and special hinge
44	CONSOLE 252 + SYSTEMCAL MOUSSE	Great bracket and transport protection
45	WARDROBE ACCESSORIES	Wardrobe lift and pant holders
46	PUSH-PULL + ROD	Opening system without handles
47	STOPORTE, CALPORTE, BLOCPORTE, STOPTAC	Doorblockers
48	SYSTEMCAL DOOR	Doorblockers
49	THE TOOL BOX	5 tools in one box
50	GENARAL SALE CONDITIONS	

SYSTEM + PRUNIER presents to you on 48 pages a lot of innovative accessories for interior design, for all kind of constructions and building, therefor these new products.



NEW PRODUCTS IN THIS CATALOGUE

Selfstick angle profiles

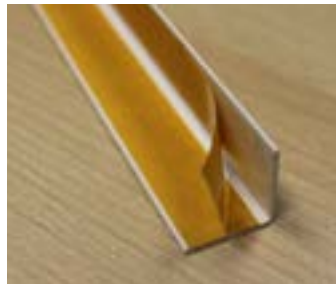

Ready to fit !
With double sided tape
Length 2,60 m

+ details Page 32

SYSTEMCAL door



Innovativ door blocker
to wedge the door open.
Very useful !

+ details Page 48

Bumper «SOFT»



Silentac super-quiet !
Ensure a soft and quiet close for any door,
drawer an enclosure.

+ details Page 38

Obturateur décoratif



Hides holes !
Finishing plugs in 40 colours.

+ de détails Page 13

Personalized packaging

Your logo free !
A product with your name to seduce
and retain your customers.

+ details Page 49





Multitasking shovel for adjustment, rising, locking

The second hand on the building site

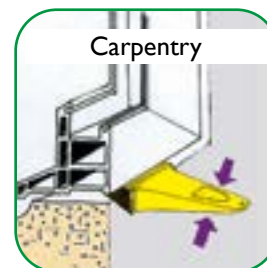
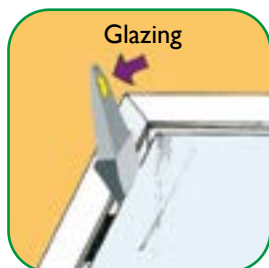

So indispensable that you will always use several of them permanently for the fitting of carpentry in ALU or PVC, frontages, equipment, adjustment for glass products, stones, marbles, for locking or rising doors and a lot of other uses.

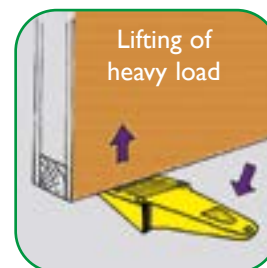

With non-skid bumpers for locking (doors, stocking)
Only on Art. 795

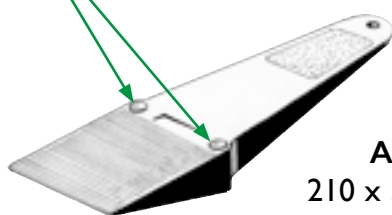

Art. 795
210 x 57 x 31 mm

Art. 795 M Plastic high resistance
For glazing (black) 210 x 57 x 31 mm



Art.	Colour	Code	Designation	Packaging	100/€net	Box/€net	Qty.
795		LRJS795	Multitasking shovel	Box with 10 pieces	909,50 €	90,95 €	10
		LRJE795	Multitasking shovel	Box ECO with 50 pieces	770,80 €	385,40 €	50
795M		LRNP795	Multitasking shovel *	Box with 5 pieces	1132,00 €	56,60 €	5
		LRNE795	Multitasking shovel *	Box ECO with 20 pieces	1037,00 €	207,40 €	20



WEDGE SYSTEMCAL



Art. 500
20 x 15 x 6 mm
Sawtooth

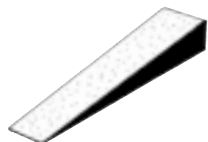

Art. 501
75 x 15 x 8 mm
Cuttable

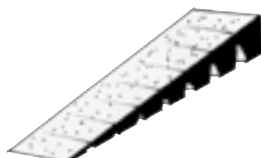

Art. 501 S
100 x 20 x 8 mm
with break points

Small assortment
500 et 501
look page 27
Art. 1526



Art.	Colour	Code	Designation	Packaging	100/€net	Box/€net	Qty.
500		MC*P500	Sawtooth 20 x 15 x 6 mm	Box with 200 pieces	23,60 €	47,20 €	200
		MC*E500	Sawtooth 20 x 15 x 6 mm	Box ECO with 1000 pieces.	17,25 €	172,50 €	1000
501		CO*P501	Wedge 75 x 15 x 8 mm	Box with 100 pieces	39,05 €	39,05 €	100
		CO*E501	Wedge 75 x 15 x 8 mm	Box ECO with 1000 pieces.	23,60 €	236,00 €	1000
501S		C*P501S	Breakable 100 x 20 x 8 mm	Box with 100 pieces	39,30 €	39,30 €	100
		C*E501S	Breakable 100 x 20 x 8 mm	Box ECO with 1000 pieces.	29,50 €	295,00 €	1000

Spring frame packers

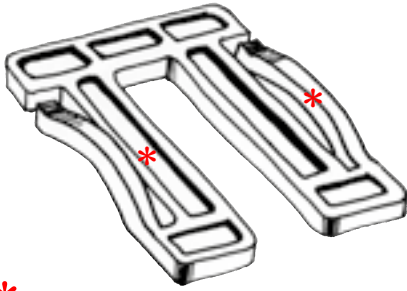

* Two wings makes the difference

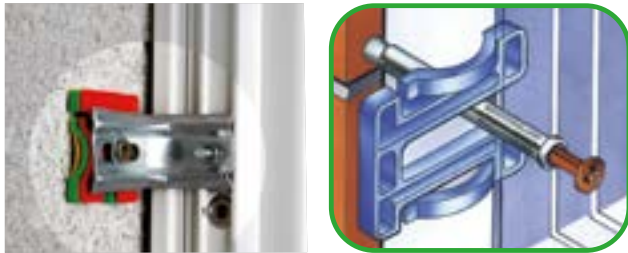

These frames stay exactly where you want

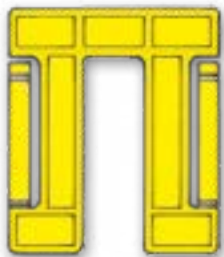

Art. 741
42 x 50 x 1,5 mm
yellow



Art. 743
42 x 50 x 3 mm
red

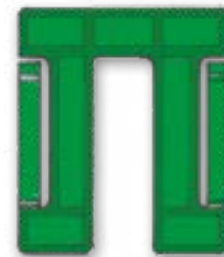

Art. 745
42 x 50 x 5 mm
green

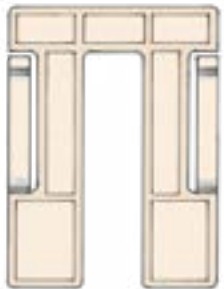

Art. 761
42 x 60 x 1,5 mm
beige



Art. 763
42 x 60 x 3 mm
blue

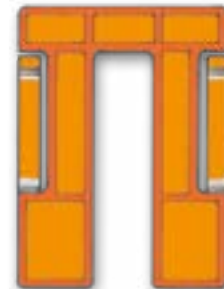

Art. 765
42 x 60 x 5 mm
orange

Art.	Colour	Code	Designation	Packaging	100/€net	Box/€net	Qty.
741	Yellow	CJP741 I	Spring frame packer 1,5 mm	Bag with 100 pieces	17,90 €	17,90 €	100
		CJE741 I	Spring frame packer 1,5 mm	Box with 1000 pieces	14,80 €	148,00 €	1000
743	Red	CRP7433	Spring frame packer 3 mm	Bag with 100 pieces	22,40 €	22,40 €	100
		CRE7433	Spring frame packer 3 mm	Box with 1000 pieces	18,95 €	189,50 €	1000
745	Green	CVP7455	Spring frame packer 5 mm	Bag with 100 pieces	29,20 €	29,20 €	100
		CVE7455	Spring frame packer 5 mm	Box with 1000 pieces	24,00 €	240,00 €	1000
746	Assortment	ACAP746	Assortment small packers	Box 3 x 200 cales	*	131,70 €	600
761	Beige	CCP761 I	Spring frame packer 1,5 mm	Bag with 100 pieces	24,10 €	24,10 €	100
		CCE761 I	Spring frame packer 1,5 mm	Box with 1000 pieces	19,90 €	199,00 €	1000
763	Blue	CBP7633	Spring frame packer 3 mm	Bag with 100 pieces	30,25 €	30,25 €	100
		CBE7633	Spring frame packer 3 mm	Box with 1000 pieces	25,00 €	250,00 €	1000
765	Orange	COP7655	Spring frame packer 5 mm	Bag with 100 pieces	40,20 €	40,20 €	100
		COE7655	Spring frame packer 5 mm	Box with 1000 pieces	33,40 €	334,00 €	1000
766	Assortment	ACAP766	Assortment big packers	Box 3 x 200 cales	*	179,50 €	600



individuel frame packers 30 x 40



1 mm
2 mm
3 mm
4 mm
5 mm



Made of Polypropylene
5 thicknesses available
Available as mixed assortment *



Used in all areas on the building site

- ▶ Roof, ceiling, walls (wood, aluminum, PVC)
- ▶ Terraces (wood, laminate)
- ▶ Interior fittings (cupboards, kitchens, etc.)
- ▶ Window and door installation
- ▶ Different use (furniture, tables, etc., etc.)

The saw tooth allows to use screws \varnothing 4 of 6 mm with a perfect superposition of the frames to the desired thickness. For fixing with ankles, the diameter can be increased to 12 mm (saw tooth strip self-braekable).



Art. 7011
30 x 40 x 1 mm
Green



Art. 7012
30 x 40 x 2 mm
Black



Art. 7013
30 x 40 x 3 mm
White



Art. 7014
30 x 40 x 4 mm
Grey



Art. 7015
30 x 40 x 5 mm
Blue



Art.	Colour	Code	Designation	Packaging	100/€net	Box/€net	Qty.
7011	Green	CVP7011	Frame packer 1 mm	Bag with 100 pieces	5,10 €	5,10 €	100
7012	Black	CNP7012	Frame packer 2 mm	Bag with 100 pieces	6,35 €	6,35 €	100
7013	White	CWP7013	Frame packer 3 mm	Bag with 100 pieces	7,45 €	7,45 €	100
7014	Grey	CGP7014	Frame packer 4 mm	Bag with 100 pieces	8,55 €	8,55 €	100
7015	Blue	CBP7015	Frame packer 5 mm	Bag with 100 pieces	9,40 €	9,40 €	100
7001	Mixed	AKP7001	Ass. 20 pieces each thickness	Bag with 100 pieces	*	9,20 €	100
7011	Green	CVE7011	Frame packer 1 mm	Box with 1000 pieces	4,60 €	46,00 €	1000
7012	Black	CNE7012	Frame packer 2 mm	Box with 1000 pieces	5,65 €	56,50 €	1000
7013	White	CWE7013	Frame packer 3 mm	Box with 1000 pieces	6,55 €	65,50 €	1000
7014	Grey	CGE7014	Frame packer 4 mm	Box with 1000 pieces	7,45 €	74,50 €	1000
7015	Blue	CBE7015	Frame packer 5 mm	Box with 1000 pieces	8,40 €	84,00 €	1000
7001	Mixed	AKS7001	Ass. 200 pieces each thickness	Box with 5 x 200 pieces	*	75,30 €	1000
7001	Mixed	AKX7001	Ass. 200 pieces each thickness	10 assortments and more	*	68,35 €	1000



Product range of fitting wedges

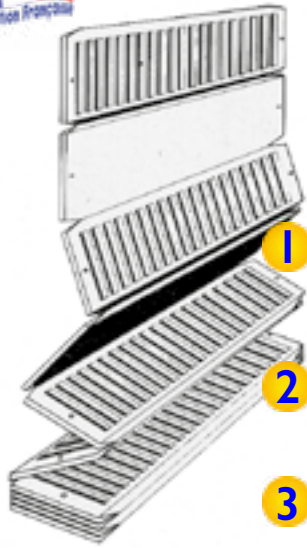

The wedges which stay in place with its special spring system.

1 Joined together with hinges.

2 With break points.

3 Possibility of every thickness by simply folding.

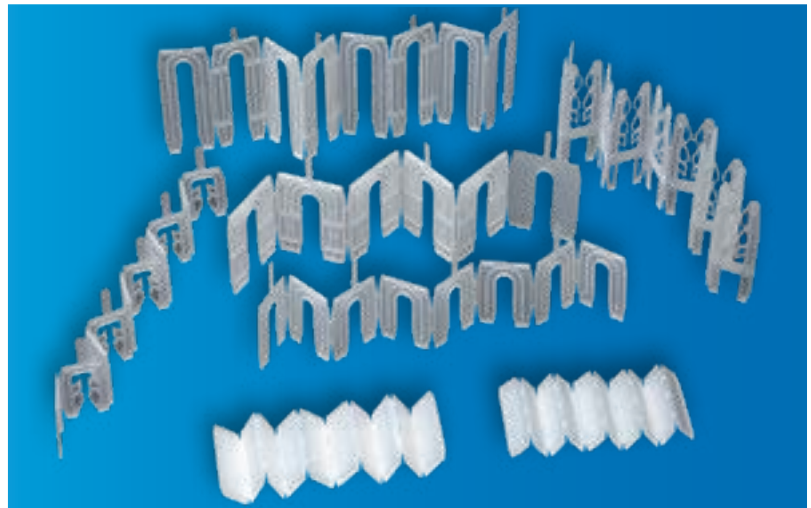
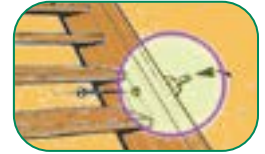

Art. 750

16 x 50 x 1,3 mm
Strip with 10 wedges



Art. 751

20 x 50 x 1,3 mm
Strip with 10 wedges



Art. 701

30 x 40 x 1,3 mm
Strip with 10 wedges



Art. 720

36 x 45 x 1,7 mm
Strip with 8 wedges

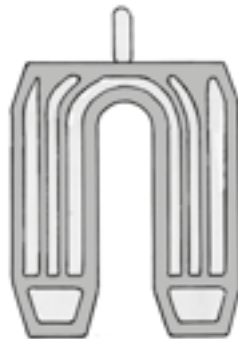

Art. 721

50 x 60 x 2 mm
Strip with 6 wedges



Art. 702

30 x 80 x 1,3 mm
Strip with 10 wedges

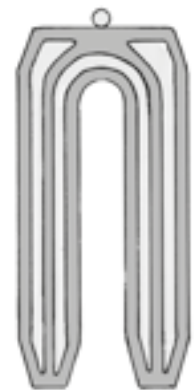

Art. 722

36 x 80 x 1,7 mm
Strip with 8 wedges

Art.	Colour	Code	Designation	Packaging	100/€net	Box/€net	Qty.
701		SCJP701	Wedge 30 x 40 mm for screw ø 7 mm	Box : 100 chains with 10 wedges	48,25 €	48,25 €	100
		SCIS701		10 boxes and more (price 1 box)	46,50 €	46,50 €	100
702		SCJP702	Wedge 30 x 80 mm for screw ø 7 mm	Box : 100 chains with 10 wedges	59,15 €	59,15 €	100
		SCIS702		10 boxes and more (price 1 box)	56,75 €	56,75 €	100
720		SCJP720	Wedge 36 x 45 mm for screw ø 10 mm	Box : 100 chains with 8 wedges	62,75 €	62,75 €	100
		SCIS720		10 boxes and more (price 1 box)	61,20 €	61,20 €	100
722		SCJP722	Wedge 36 x 80 mm for screw ø 10 mm	Box : 100 chains with 8 wedges	64,45 €	64,45 €	100
		SCIS722		10 boxes and more (price 1 box)	62,40 €	62,40 €	100
721		SCJP721	Wedge 50 x 60 mm for screw ø 12 mm	Box : 100 chains with 6 wedges	73,90 €	73,90 €	100
		SCIS721		10 boxes and more (price 1 box)	71,90 €	71,90 €	100
750		SCJP750	Wedge 16 x 50 mm	Box : 100 chains with 10 wedges	41,10 €	41,10 €	100
		SCIS750		10 boxes and more (price 1 box)	39,20 €	39,20 €	100
751		SCJP751	Wedge 20 x 50 mm	Box : 100 chains with 10 wedges	43,30 €	43,30 €	100
		SCIS751		10 boxes and more (price 1 box)	41,60 €	41,60 €	100

Plastic flat packers for glazing and fitting

Plastic flat packers indispensables for the whole building industry



- **strong**
- **will not corrode**
- **many sizes**
- **draining grooves**
- **anti slip grooves**



Art. AKP + 30 x 18 = 540 spacers

Colour	Height	Length	Width	Qty
GREEN	1 mm	20 mm	100 mm	30
GREEN	1 mm	24 mm	100 mm	30
GREEN	1 mm	28 mm	100 mm	30
BLACK	2 mm	20 mm	100 mm	30
BLACK	2 mm	24 mm	100 mm	30
BLACK	2 mm	28 mm	100 mm	30
WHITE	3 mm	20 mm	100 mm	30
WHITE	3 mm	24 mm	100 mm	30
WHITE	3 mm	28 mm	100 mm	30
GREY	4 mm	20 mm	100 mm	30
GREY	4 mm	24 mm	100 mm	30
GREY	4 mm	28 mm	100 mm	30
BLUE	5 mm	20 mm	100 mm	30
BLUE	5 mm	24 mm	100 mm	30
BLUE	5 mm	28 mm	100 mm	30
RED	6 mm	20 mm	100 mm	30
RED	6 mm	24 mm	100 mm	30
RED	6 mm	28 mm	100 mm	30

Very useful assortment !

Red	6 mm
Blue	5 mm
Grey	4 mm
White	3 mm
Black	2 mm
Green	1 mm



Art. 4520
Assortment 520 Soft Spacers Polyethylene
Only as long as available

Art.	Colour	Code	Designation	Packaging	100/€net	Box/€net	Qty.
KP20		KPIVE20	Spacer 20 x 100 x 1 mm	Box with 1000 spacers	6,45 €	64,50 €	1000
		KP2NE20	Spacer 20 x 100 x 2 mm	Box with 1000 spacers	7,40 €	74,00 €	1000
		KP3VE20	Spacer 20 x 100 x 3 mm	Box with 1000 spacers	7,90 €	79,00 €	1000
		KP4GE20	Spacer 20 x 100 x 4 mm	Box with 1000 spacers	9,40 €	94,00 €	1000
		KP5BE20	Spacer 20 x 100 x 5 mm	Box with 1000 spacers	10,30 €	103,00 €	1000
		KP6RE20	Spacer 20 x 100 x 6 mm	Box with 1000 spacers	11,65 €	116,50 €	1000
AKP20		AK20S12	Assortment 20 x 100 mm	Assortment 1200 spacers	*	129,60 €	1200
KP24		KPIVE24	Spacer 24 x 100 x 1 mm	Box with 1000 spacers	7,80 €	78,00 €	1000
		KP2NE24	Spacer 24 x 100 x 2 mm	Box with 1000 spacers	8,70 €	87,00 €	1000
		KP3VE24	Spacer 24 x 100 x 3 mm	Box with 1000 spacers	10,30 €	103,00 €	1000
		KP4GE24	Spacer 24 x 100 x 4 mm	Box with 1000 spacers	12,60 €	126,00 €	1000
		KP5BE24	Spacer 24 x 100 x 5 mm	Box with 1000 spacers	14,10 €	141,00 €	1000
		KP6RE24	Spacer 24 x 100 x 6 mm	Box with 1000 spacers	15,70 €	157,00 €	1000
AKP24		AK24S12	Assortment 24 x 100 mm	Assortment 1200 spacers	*	166,70 €	1200
KP28		KPIVE28	Spacer 28 x 100 x 1 mm	Box with 1000 spacers	9,40 €	94,00 €	1000
		KP2NE28	Spacer 28 x 100 x 2 mm	Box with 1000 spacers	10,60 €	106,00 €	1000
		KP3VE28	Spacer 28 x 100 x 3 mm	Box with 1000 spacers	11,65 €	116,50 €	1000
		KP4GE28	Spacer 28 x 100 x 4 mm	Box with 1000 spacers	12,60 €	126,00 €	1000
		KP5BE28	Spacer 28 x 100 x 5 mm	Box with 1000 spacers	13,40 €	134,00 €	1000
		KP6RE28	Spacer 28 x 100 x 6 mm	Box with 1000 spacers	14,10 €	141,00 €	1000
AKP28		AK28S12	Assortment 28 x 100 mm	Box with 1000 spacers	*	172,30 €	1200
AKP+		KKPS540	Assortment 20, 24 et 28 mm	Box with 1000 spacers	*	79,20 €	540
AKP+		KKPX540	Assortment 20, 24 et 28 mm	more than 10 boxes	*	71,55 €	540
4520		KDS4520	Ass. Polyethylene	520 soft spacers	*	171,55 €	520

Special flat packers for heavy load 44 x 100

Durometer SHORE D - 70
Maximal load 3,5 tonnes by spacer

2 mm



3 mm



4 mm



5 mm

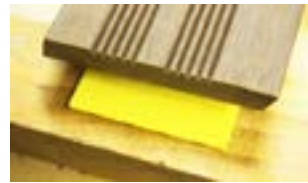

Resistant
Rot-proof
Different thicknesses
Self draining
Anti-slip grooves



SPACERS SPECIAL HEAVY LOAD

- ▶ Outside Insulation
- ▶ Glass facades, curtain walls
- ▶ Metallic gates, garage doors
- ▶ Marble etc.
- ▶ Wood frame houses
- ▶ Floors, terraces public places
- ▶ Prefabrications

We offer for all building professions an assortment with 100 wedges of each thickness. Useful and practical.



Art. KP44-2
44 x 100 x 2 mm
Grey



Art. KP44-3
44 x 100 x 3 mm
Bordeaux



Art. KP44-4
44 x 100 x 4 mm
Yellow



Art. KP44-5
44 x 100 x 5 mm
Green

Art.	Colour	Code	Designation	Packaging	100/€net	Box/€net	Qty.
KP44		KP2GE44	Spacer 44 x 100 x 2 mm	Box with 500 spacers	39,85 €	199,25 €	500
		KP3DE44	Spacer 44 x 100 x 3 mm	Box with 500 spacers	42,90 €	214,50 €	500
		KP4JE44	Spacer 44 x 100 x 4 mm	Box with 500 spacers	45,80 €	229,00 €	500
		KP5VE44	Spacer 44 x 100 x 5 mm	Box with 500 spacers	46,75 €	233,75 €	500
AKP44		AK44S04	Assortment 44 x 100 mm	Assortment 400 Spacers	*	175,20 €	400



The wedges for every use essential complement for our BLOCfiX

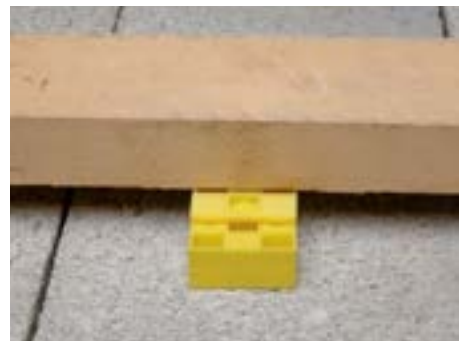

Assortment box

Assortment 260 wedges :

- 70 x 3010
- 90 x 408F
- 60 x 4515
- 40 x 4525



FOR ALL APPLICATION IN THE BUILDING TRADE :
Floors, embedding, carpentry, walls and partitions, scaffolding, frame, construction ...



*Insenible against dampness and variations of temperatures.
Possible to screw or to nail.*



Art. 3010
80 x 30 x 10 mm

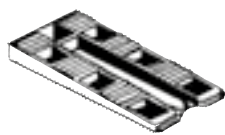

BRIDGE
Art. 408F
80 x 40 x 8 mm

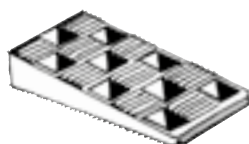

Art. 4515
90 x 45 x 15 mm

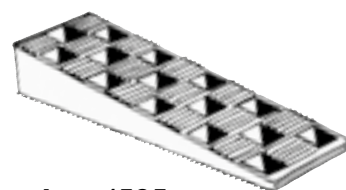

Art. 4525
140 x 45 x 25 mm

art.	Colour	Code	Designation	Packaging	100/€net	Box/€net	Qty.
3010	Green	KDSVP10	Wedge KDS 3010	Box with 100 pieces	62,15 €	62,15 €	100
		KDSVE10	Wedge KDS 3010	Box ECO with 350 pieces	52,90 €	185,15 €	350
		KDSVM10	Wedge KDS 3010	Box MAXI with 1000 pieces	43,00 €	430,00 €	1000
408F	Orange	KDSOP8F	Wedge KDS 408F	Box with 80 pieces	64,87 €	51,90 €	80
		KDSOE8F	Wedge KDS 408F	Box ECO with 350 pieces	55,50 €	194,25 €	350
		KDSOM8F	Wedge KDS 408F	Box MAXI with 1000 pieces	45,47 €	454,70 €	1000
4515	Brown	KDSMP15	Wedge KDS 4515	Box with 48 pieces	78,33 €	37,60 €	48
		KDSME15	Wedge KDS 4515	Box ECO with 175 pieces	69,14 €	121,00 €	175
		KDSMM15	Wedge KDS 4515	Box MAXI with 960 pieces	58,99 €	566,30 €	960
4525	Yellow	KDSJP25	Wedge KDS 4525	Box with 18 pieces	132,24 €	23,80 €	18
		KDSJE25	Wedge KDS 4525	Box ECO with 130 pieces	118,96 €	154,65 €	130
		KDSJM25	Wedge KDS 4525	Box MAXI with 500 pieces	108,92 €	544,60 €	500
4260	Assortment	KDS4260	Assortment 260 wedges (70 : 3010 90 : 408F - 60 : 4515 - 40 : 4525)	Box with 260 pieces	*	180,90 €	1
		KDX4260		more than 10 boxes	*	167,40 €	1



Special wedges for great distance

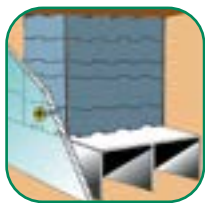

For the fitting of cupboards, carpentry, floors, etc. Made of restores plastic. et (indissoluble) with pile-up wedges is advised to be screwed or nailed after adjustment.

Art. 740
80 x 40 mm
Set with 6 wedges
10 - 12,5 - 15 - 17,5 - 20 et 25 mm.
Not available separately.



Art.	Colour	Code	Designation	Packaging	100/€net	Box/€net	Qty.
740		BFNP740	Set with 6 wedges	Box with 10 sets	367,50 €	36,75 €	10
		BFNE740	Set with 6 wedges	Box with 100 sets	306,55 €	306,55 €	100

KIT TERRACE KDFIX



Kit for wooden decking

composed of 2 KDS 408F and 4 cm de wedges BLOCFIX in 2 or 3 pièces, to realize all compositions from 1 to 5 cm.

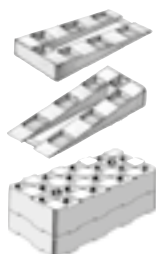

Art. 942
80 x 40 x 50 mm



Height from 1 to 5 cm

Allows to square the rafters of the terrace by isolating them from the moisture of the ground. After adjustment, secure the KDFIX by nailing, screwing or gluing.

Art.	Colour	Code	Designation	Packaging	100/€net	Box/€net	Qty.
942		KDFS942	Kit terrasse	Box with 25 kits	295,40 €	73,85 €	25
		KDFX942	Kit terrasse	Box ECO 50 kits	280,40 €	140,20 €	50

CLIPS TERRACE



High-resistant clips for terrace floors

for invisible fitting (leave 5 or 7,5 mm). Made of Polyamide

Important: Verify manufacturing that the lathes suits to the clips. Use Inox screws for fitting



Réf. C535

26 x 17 x 8 mm

Trou pour vis ø 3,5 mm



Réf. C755

27 x 19,5 x 9 mm

Trou pour vis ø 5 mm

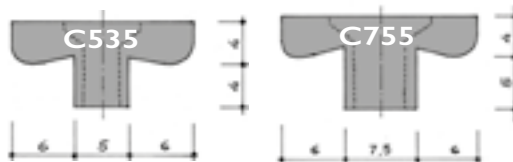

Art.	Colour	Code	Designation	Packaging	100/€net	Box/€net	Qty.
C535		CTPC535	Clips Terrasse	Box with 250 pieces	41,68 €	104,20 €	250
C755		CTPC755	Clips Terrasse	Box with 250 pieces	45,20 €	113,00 €	250



Spatulas for all pointings in mastic

This product range is perfectly adapted for all kind of use, for different mastics (silicone, acrylic, etc) and for all kind of supports (Alu, PVC, Inox, wood, stratified)



SILNET C.B.
WHITE



The economic
60 x 72 x 6 mm
Art. 780

SILNET S.P.R.
RED



Special glazing
80 x 90 x 5 mm
Art 600

SILNET S.P.B.
BLUE



The versatile
80 x 90 x 5 mm
Art. 610



Art.	Colour	Code	Description	Packaging	100/€net	Box/€net	Qty.
780		SILB780	Economic spatula	5 bags with each 4 spatulas	245,50 €	49,10 €	20
		SILE786	Economic spatula	Box with 50 spatulas	122,00 €	61,00 €	50
		SILM787	Economic spatula	Box ECO with 250 spatulas	98,00 €	245,00 €	250
600		SPRP600	Glazing spatula	5 bags with each 2 spatulas	430,00 €	43,00 €	10
		SPRV601	Glazing spatula	Box with 40 spatulas	294,62 €	117,85 €	40
		SPRE602	Glazing spatula	Box ECO with 200 spatulas	256,80 €	513,60 €	200
610		SPBP610	Versatile spatula	5 bags with each 2 spatulas	538,50 €	53,85 €	10
		SPBV611	Versatile spatula	Box with 40 spatulas	387,25 €	154,90 €	40
		SPBE612	Versatile spatula	Box ECO with 200 spatulas	341,85 €	683,70 €	200

PASSE SYSTEM



To replace all tools below



PASSE SYSTEM, the Universal key

Made of composite material
= SECURITY (non Conducteur) = LIGHTNESS = RESISTANCE

Art. 515
130 x 60 x 18 mm



It will allow all access points beside
Square 4 to 10 mm, Cylinder C.E., triangle, counter



Art.	Colour	Code	Description	Packaging	100/€NET	Box/€ NET	Qty.
515		PASP515	Passe system	Box with 10 individual bags	1477,50 €	147,75 €	10
		PASE515	Passe system	Box ECO with 50 individual bags	1043,90 €	521,95 €	50

Multi-purpose gliding feet

For wooden floor, tiled floor, carpeting etc.



- Art. 525
ø 16 x 3,5 mm
- Art. 526
ø 22 x 3,5 mm
- Art. 527
ø 26 x 3,5 mm
- Art. 528
ø 34 x 3,5 mm

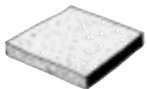
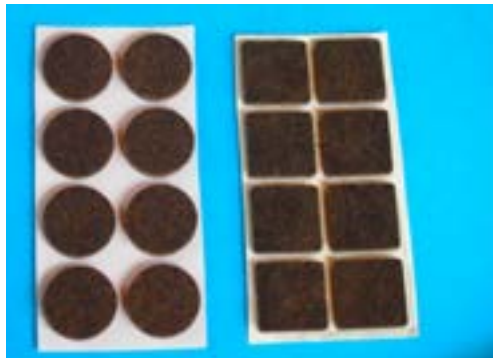

Art. 529
25 x 25 x 3,5 mm

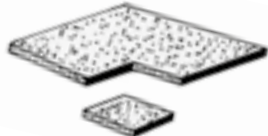

Art. 530 to cut
200 x 200 x 3,5 mm



For screwing, nailing or adhesive



Art. 516
ø 16 x 5 mm



Art. 519
ø 19 x 5 mm



Art. 510 felt
ø 20 x 8 mm



Art. 512 felt
ø 20 x 8 mm
* reinforced nail



Art. 518 metal
ø 18 x 8 mm



Art. 116 plastic
ø 18,5 x 11 mm



Art. 524 feutre
ø 24 x 8 mm with screw



Art. 521 white
44 x 18 x 5 mm



Art. 511 felt
38 x 18 x 8 mm



Art	Colour	Code	Designation	Packaging	100/€NET	La Bte/€NET	Qty.
116		PLOPI16	Pin to screw ø 18,5 mm	Box with 100 pieces	11,90 €	11,90 €	100
		PLOEI16	Pin to screw ø 18,5 mm	Boîte ECO de 1000 pièces	9,45 €	94,50 €	1000
510		PC*P510	Nail-on glide ø 20 mm	Box with 100 pieces	30,40 €	30,40 €	100
		PC*E510	Nail-on glide ø 20 mm	Boîte ECO de 1000 pièces	27,30 €	273,00 €	1000
512		PC*P512	Nail-on glide ø 20 mm *	Box with 100 pieces	57,90 €	57,90 €	100
		PC*E512	Nail-on glide ø 20 mm *	Boîte ECO de 1000 pièces	53,15 €	531,50 €	1000
511		PFGP511	Nail-on glide 38 mm	Box with 100 pieces	130,05 €	130,05 €	100
		PFGE511	Nail-on glide 38 mm	Boîte ECO de 1000 pièces	117,15 €	1171,50 €	1000
518		PLMP518	Metal glide ø 18 mm	Box with 100 pieces	7,30 €	7,30 €	100
		PLME518	Metal glide ø 18 mm	Boîte ECO de 1000 pièces	6,55 €	65,50 €	1000
516		PL*P516	Nail-on glide ø 16 mm	Box with 100 pieces	7,95 €	7,95 €	100
		PL*E516	Nail-on glide ø 16 mm	Boîte ECO de 1000 pièces	7,00 €	70,00 €	1000
519		PL*P519	Nail-on glide ø 19 mm	Box with 100 pieces	9,90 €	9,90 €	100
		PL*E519	Nail-on glide ø 19 mm	Boîte ECO de 1000 pièces	8,75 €	87,50 €	1000
521		PDBP521	Nail-on glide 44 mm	Box with 100 pieces	45,70 €	45,70 €	100
		PDBE521	Nail-on glide 44 mm	Boîte ECO de 1000 pièces	41,15 €	411,50 €	1000
524		PV*P524	Pin to screw ø 24 mm	Box with 100 pieces	47,60 €	47,60 €	100
		PV*E524	Pin to screw ø 24 mm	Boîte ECO de 1000 pièces	42,85 €	428,50 €	1000
525		PF*P525	Adhesive glide ø 16 mm	Bag with 50 pieces	5,30 €	2,65 €	50
526		PF*P526	Adhesive glide ø 22 mm	Bag with 30 pieces	8,83 €	2,65 €	30
527		PF*P527	Adhesive glide ø 26 mm	Bag with 24 pieces	11,04 €	2,65 €	24
528		PF*P528	Adhesive glide ø 34 mm	Bag with 12 pieces	22,08 €	2,65 €	12
529		PF*P529	Adhesive glide 25 x 25 mm	Bag with 24 pieces	11,04 €	2,65 €	24
530		PF*P530	Plate to cut	Bag	220,00 €	2,20 €	1

Adhesive covers for holes or screws

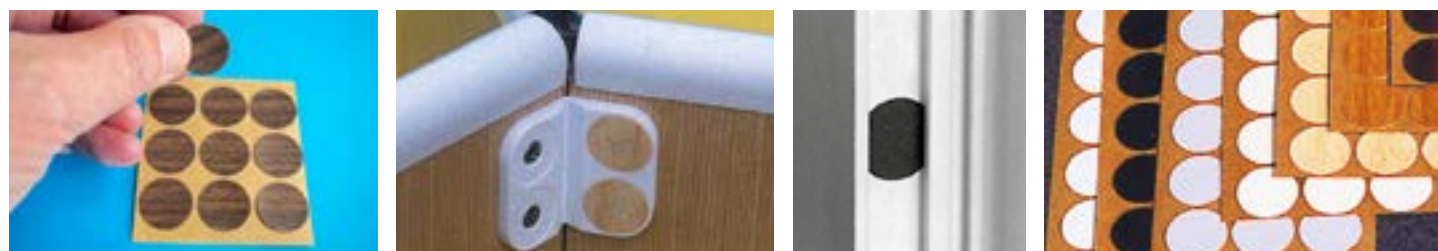
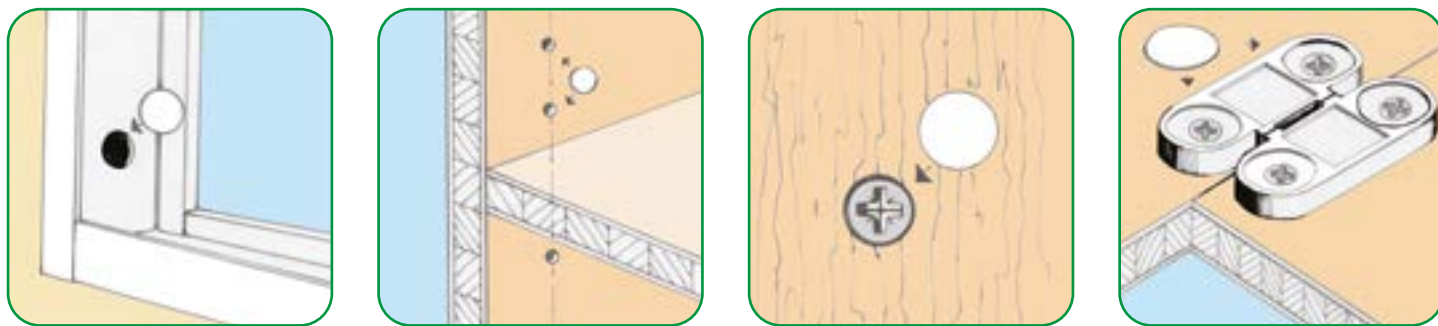

Made of PVC one side adhesive, SYSTEMCACH is indispensable for the finishing of your carpentries, fittings, decoration etc...

Art. 712
ø 12 mm



Art. 715
ø 15 mm



Art. 781
ø 19,5 mm

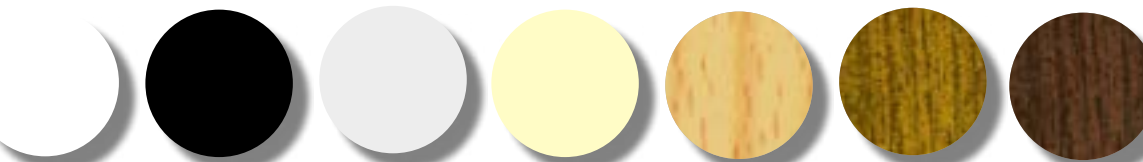

WHITE

BLACK

GREY

IVORY

PINE

LIGHT OAK

DARK OAK

Art	Colour	Code	Description	Packaging	100/€net	Box/€net	Qty.
712	Colours see here above	SK*F712	Hole cover ø 12 mm	Bag with 100 pieces	8,70 €	8,70 €	100
		SK*B712		Bag with 500 pieces	7,02 €	35,10 €	500
		SK*R712		Roll ECO with 3000 pieces	5,42 €	162,60 €	3000
715	Colours see here above	SK*F715	Hole cover ø 15 mm	Bag with 100 pieces	8,85 €	8,85 €	100
		SK*B715		Bag with 500 pieces	7,18 €	35,90 €	500
		SK*R715		Roll ECO with 3000 pieces	5,48 €	164,40 €	3000
781	Colours see here above	SK*F783	Hole cover ø 19,5 mm	Bag with 96 pieces	9,58 €	9,20 €	96
		SK*B781		Bag with 500 pieces	7,67 €	38,35 €	500
		SK*R782		Roll ECO with 3000 pieces	5,67 €	170,10 €	3000

40 colours available

A very large range to cover up holes for every surface.

Self stick hole covers

Décoratif plugs















Art. 713
 ø 13 mm
 Uni or wood imitation

Art. 714
 ø 13 mm
 metallic

























Art. 716
 Uni or wood imit.
Art. 717
 metallic
 ø 13 x 8 mm
 for holes ø 10 mm

Art. 718
 Uni or wood imit.
Art. 719
 metallic
 ø 15 x 8 mm
 for holes ø 12 mm

Uni



-  **01** White
-  **02** White wood texture
-  **03** White mat
-  **04** Creme dark
-  **05** Creme light
-  **06** Black
-  **07** Black wood texture
-  **08** Clear-grey
-  **09** Dark grey
-  **10** Silver-grey
-  **11** paintable

Imitation wood

-  **12** Maple 257
-  **13** Maple 277
-  **14** Birch 258
-  **15** Birch 260
-  **16** Cherry 9019
-  **17** Cherry 9030
-  **18** Cherry 9049
-  **19** Cherry 374
-  **20** Beech 168
-  **21** Limba
-  **22** Mahogany 988
-  **23** Walnut 6045
-  **24** Walnut 6077
-  **25** Walnut 6078
-  **26** Oak 4501
-  **27** Pine 282
-  **28** Pine 283
-  **29** Pine 2102
-  **30** Oak clear 4569
-  **31** Oak 4548
-  **32** Oak 4557
-  **33** Oak 4647
-  **34** Sycomore Platane
-  **35** Wenge wood stucture
-  **36** Wenge 9005

Metallic

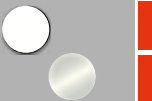
-  **37** Alu met 06
-  **38** Alu met 07
-  **40** Chrome

	Art	Colour	Code	Designation	Packaging	100/€net	Bag / €net	Qty.
	713	see above	K**F713	Cover cap ø 13 mm uni or wood imitation	Bag with 100 pieces	7,95 €	7,95 €	100
	714		K**F714	Cover cap ø 13 mm metallic	Bag with 100 pieces	9,15 €	9,15 €	100
	716	uni or wood imit.	O**F716	Plug ø 13 mm for hole ø 10 mm	Bag with 100 pieces	9,10 €	9,10 €	100
	717	metallic	O**F717	Plug ø 13 mm for hole ø 10 mm	Bag with 100 pieces	11,55 €	11,55 €	100
	718	uni or wood imit.	O**F718	Plug ø 15 mm for hole ø 12 mm	Bag with 100 pieces	11,85 €	11,85 €	100
	719	metallic	O**F719	Plug ø 15 mm for hole ø 12 mm	Bag with 100 pieces	15,15 €	15,15 €	100



Covers for hex screws/nuts



Art. 10CE spanner (A/F) 10
ø 13 x 13 mm

Art. 13CE spanner (A/F) 13
ø 17 x 15 mm

Art. 16CE spanner (A/F) 16
ø 21 x 19 mm



Art.	Colour	Code	Description	Packaging	100/€net	Bag/€net	Qty.
10CE		C*PI0CE	Cover for nuts 10	Bag with 100 pieces	16,75 €	16,75 €	100
		C*EI0CE	Cover for nuts 10	Bag ECO with 500 pieces	15,00 €	75,00 €	500
13CE		C*PI3CE	Cover for nuts 13	Bag with 100 pieces	17,20 €	17,20 €	100
		C*EI3CE	Cover for nuts 13	Bag ECO with 500 pieces	15,45 €	77,25 €	500
16CE		C*PI6CE	Cover for nuts 16	Bag with 100 pieces	21,90 €	21,90 €	100
		C*EI6CE	Cover for nuts 16	Bag ECO with 500 pieces	19,75 €	98,75 €	500



FINISHING WASHERS

Nylon finishing washers



Art. 4V12 for screw ø 4 mm
ø 12 x 3 mm

Art. 5V15 for screw ø 4 mm
ø 15 x 3,5 mm

Art. 6V17 for screw ø 4 mm
ø 17 x 4,5 mm



Art.	Colour	Code	Description	Packaging	100/€net	Bag/€net	Qty.
4V12		R*P4V12	Cover for nuts 10	Bag with 100 pieces	20,35 €	20,35 €	100
		R*E4V12	Cover for nuts 10	Bag ECO with 500 pieces	18,45 €	92,25 €	500
5V15		R*P5V15	Cover for nuts 13	Bag with 100 pieces	23,15 €	23,15 €	100
		R*E5V15	Cover for nuts 13	Bag ECO with 500 pieces	20,95 €	104,75 €	500
6V17		R*P6V17	Cover for nuts 16	Bag with 100 pieces	29,75 €	29,75 €	100
		R*E6V17	Cover for nuts 16	Bag ECO with 500 pieces	26,80 €	134,00 €	500



COVER PLUGS

Plastic cover plugs



Art. 1013 for holes ø 10 mm
ø 13 x 7 mm

Art. 1215 for holes ø 12 mm
ø 15 x 7 mm



Art.	Colour	Code	Description	Packaging	100/€net	Bag/€net	Qty.
1013		O*PI013	Cover plug hole 10 mm	Bag with 100 pieces	9,30 €	9,30 €	100
		O*EI013	Cover plug hole 10 mm	Bag ECO with 500 pieces	8,45 €	42,25 €	500
1215		O*PI215	Cover plug hole 12 mm	Bag with 100 pieces	9,65 €	9,65 €	100
		O*EI215	Cover plug hole 12 mm	Bag ECO with 500 pieces	8,85 €	44,25 €	500

SCREW CAP

Decorative caps for rolling shutters etc.



Art. 2055
ø 14,5 x 5 mm



Art. 2057
ø 19,5 x 8 mm



Art.	Colour	Code	Description	Packaging	100/€net	Bag/€net	Qty.
2055		ST*PO55	Screw cap ø 14,5 mm	Bag with 100 pieces	19,50 €	19,50 €	100
		ST*EO55	Screw cap ø 14,5 mm	Box ECO with 500 pieces	16,15 €	80,75 €	500
2057		ST*PO57	Screw cap ø 19,5 mm	Bag with 100 pieces	20,15 €	20,15 €	100
		ST*EO57	Screw cap ø 19,5 mm	Box ECO with 500 pieces	17,05 €	85,25 €	500

Fixtab the new support for all kind of shelves*

*from 300 to 600 mm length and 16 to 22 mm thickness



Art. 930 shelf
until 300 mm



Art. 940 shelf
until 400 mm



Art. 950 shelf
until 500 mm



Art. 960 shelf
until 600 mm



available in white, beige, grey, brown and black

Art.	Colour	Code	Description	Packaging	100/€ net	Box/€ net	Qty.
930		FIXBP30	Kit for shelves until 30 cm maximum	Bag with 5 pairs	390,00 €	19,50 €	5
		FIXBE30		10 bags with 5 pairs and more	364,00 €	18,20 €*	5
930		FIX*P30	Kit for shelves until 30 cm maximum	Bag with 5 pairs	427,00 €	21,35 €	5
		FIX*E30		10 bags with 5 pairs and more	399,00 €	19,95 €*	5
940		FIXBP40	Kit for shelves until 40 cm maximum	Bag with 5 pairs	538,00 €	26,90 €	5
		FIXBE40		10 bags with 5 pairs and more	507,00 €	25,35 €*	5
940		FIX*P40	Kit for shelves until 40 cm maximum	Bag with 5 pairs	584,00 €	29,20 €	5
		FIX*E40		10 bags with 5 pairs and more	561,00 €	28,05 €*	5
950		FIXBP50	Kit for shelves until 50 cm maximum	Bag with 5 pairs	664,00 €	33,20 €	5
		FIXBE50		10 bags with 5 pairs and more	630,00 €	31,50 €*	5
950		FIX*P50	Kit for shelves until 50 cm maximum	Bag with 5 pairs	714,00 €	35,70 €	5
		FIX*E50		10 bags with 5 pairs and more	680,00 €	34,00 €*	5
960		FIXBP60	Kit for shelves until 60 cm maximum	Bag with 5 pairs	782,00 €	39,10 €	5
		FIXBE60		10 bags with 5 pairs and more	718,00 €	35,90 €*	5
960		FIX*P60	Kit for shelves until 60 cm maximum	Bag with 5 pairs	812,00 €	40,60 €	5
		FIX*E60		10 bags with 5 pairs and more	773,00 €	38,65 €*	5

* Price for one bag



Sloped ceiling bracket

- A** High resistance turning point
- B** 4 fitting points for a perfect holding.
- C** Fastening of the decor fascia possible by screwing directly on the hanger or with 2 clips C905 which make the screws invisible

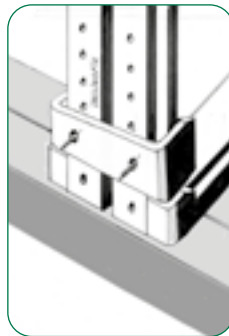

Fitting with clips : *
move the rail
3 cm forward



**For roof-pitches between
17 and 63 °**

**INVISIBLE fastening of the fascia
with 2 clips C 905**

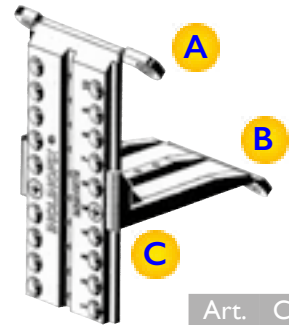

Art. C905
2 screwholes 3,5 mm
13 x 55 x 13 mm
2 Clips for each INCLINOFIX
One INCLINOFIX every 50 cm an 10 cm from each end

Art.	Colour	Code	Designation	Packging	100/€net	Box/€ net	Qty.
901		SINC901	Sloped ceiling bracket	Bag with 2 inclinofix	1020,00 €	20,40 €	2
		SINC902	Sloped ceiling bracket	50 bags with 2 inclinofix	908,30 €	8908,30 €	100
		SINC903	Sloped ceiling bracket	Box bulk 20 inclinofix	870,00 €	174,00 €	20
		SINC904	Sloped ceiling bracket	Box bulk 100 inclinofix	782,35 €	782,35 €	100
C905		CLIP905	Clip	Bag with 20 clips	34,50 €	6,90 €	20
		CLIE905	Clip	Bag ECO with 100 clips	30,50 €	30,50 €	100

SYSTEMFIX



Opening height reducer

- A** Simplicity : SYSTEMFIX consists of one post and two bases.
- B** Adjust the post to suit the distance (height or width) and fix it (screws provided) on the base units.

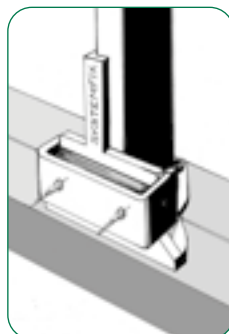

Fitting with clips *
move the rail
3 cm forward



ADJUSTMENT from 6 to 50 cm

**INVISIBLE fastening of the fascia
with 2 clips C 905**

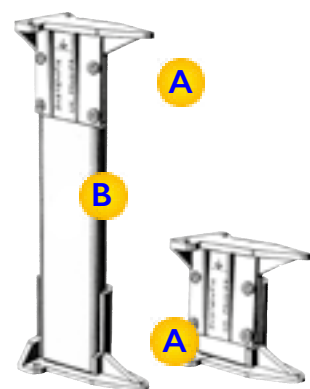

Art. C905
2 screwholes 3,5 mm
13 x 55 x 13 mm
2 Clips for each SYSTEMFIX
One SYSTEMFIX every 50 cm and 10 cm from each end

Art.	Colour	Code	Description	Packaging	100/€net	Box/€net.	Qty.
911		SFIX911	Opening height reducer	Bag with 2 pieces	1890,00 €	37,80 €	2
		SFIX912	Opening height reducer	50 bags with 2 pieces	1673,15 €	1673,15 €	100
		SFIX913	Opening height reducer	Box with 20 pieces (bulk)	1595,25 €	319,05 €	20
		SFIX914	Opening height reducer	Box with 100 pieces (bulk)	1532,30 €	1532,30 €	100
C905		CLIP905	Clip	Bag with 20 pieces	34,50 €	6,90 €	20
		CLIE905	Clip	Bag ECO with 100 pieces	30,50 €	30,50 €	100



Systemtac Pro, the most complete range

To simplify your stock the cap 010 is the same for all articles:
 One for item 01 and CH01;
 Two for item 02 and 03



COVER 010

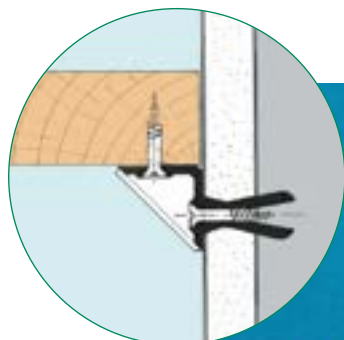
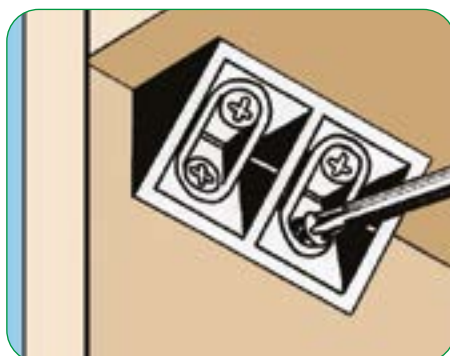

5 colours available

Corner with integrated ankle



SYSTEMTAC CH01
 24 x 22 x 22 mm
 Ankle ø 6 mm



SYSTEMTAC 01
 24 x 22 x 22 mm



SYSTEMTAC 02
 45 x 22 x 22 mm



SYSTEMTAC 03
 24 x 41 x 41 mm



SYSTEMTAC 01C
 24 x 23 x 23 mm

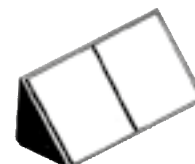

SYSTEMTAC 02C
 45 x 23 x 23 mm

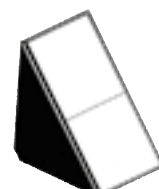

SYSTEMTAC 03C
 24 x 42 x 42 mm



Art.	Colour	Code	Description	Packaging	100/€net	Box/€net	Qty.
CH01C		*PCH01C	Ankle corner with cap	Box with 100 corners and caps	45,65 €	45,65 €	100
CH01C		*SCH01C	Ankle corner with cap	40 boxes 100 corners and caps	42,35 €	1694,00 €	4000
CH01		*ECH001	Ankle corner, 2 holes	Box ECO with 1000 pièces	34,65 €	346,50 €	1000
01		ST*E001	Corner 2 holes	Box ECO with 1000 pièces	13,25 €	132,50 €	1000
02		ST*E002	Corner 4 holes, large	Box ECO with 500 pièces	23,75 €	118,75 €	500
03		ST*E003	Corner 4 holes, high	Box ECO with 500 pièces	31,45 €	157,25 €	500
010		ST*E010	Cap *	Box ECO with 1000 pièces	4,00 €	40,00 €	1000
01C		ST*P01C	Corner with cap	Box with 100 corners and caps	29,85 €	29,85 €	100
01C		ST*S01C	Corner with cap	40 boxes 100 corners and caps	22,20 €	888,00 €	4000
02C		ST*P02C	Corner large with caps	Box with 50 corners and caps	42,30 €	21,15 €	50
02C		ST*S02C	Corner large with caps	40 boxes 50 corners and caps	37,80 €	756,00 €	2000
03C		ST*P03C	Corner high with caps	Box with 50 corners and caps	50,30 €	25,15 €	50
03C		ST*S03C	Corner high with caps	40 boxes 50 corners and caps	44,10 €	882,00 €	2000

* 1 cap for CH01 and 01, 2 caps for 02 and 03.

Tie solutions for all situations

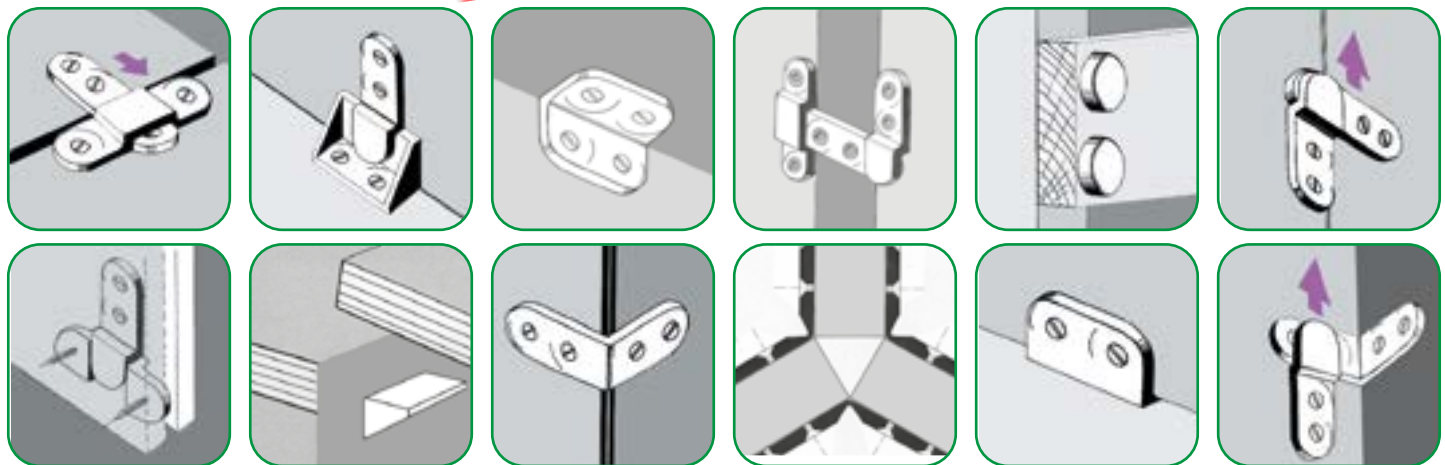

For fitting-up, storage, stands, presentation, decoration ...

The best way to assemble

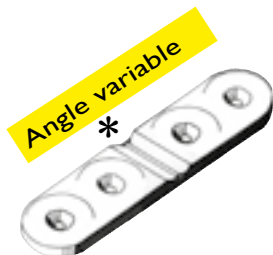

Art. 2198
22 x 95 x 5 mm



Art. 2187
22 x 49 x 49 mm



Art. 2172
44 x 55 x 5 mm



Art. 2162
44 x 28 x 28 mm

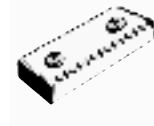

Art. 171
38 x 10 x 7 mm

* Attention : this product cannot be used as hinge

Art.	Colour	Code	Description	Packaging	100/ € net	Box/€ net	Qty
2198	Black	ST*C198	Corner variable long 4 holes	Box with 50 pieces	98,10 €	49,05 €	50
		ST*E198		Box ECO with 500 pieces	90,65 €	453,25 €	500
2187	Black	ST*P187	Brace, long 4 trous	Box with 50 pieces	98,10 €	49,05 €	50
		ST*E187		Box ECO with 500 pieces	90,65 €	453,25 €	500
2172	Black	ST*P172	Corner variable large 4 holes	Box with 50 pieces	98,10 €	49,05 €	50
		ST*E172		Box ECO with 500 pieces	90,65 €	453,25 €	500
2162	Black	ST*P162	Brace, large 4 holes	Box with 50 pieces	98,10 €	49,05 €	50
		ST*E162		Box ECO with 500 pieces	90,65 €	453,25 €	500
171	Brown	BS*P171	Plastic bracket	Bag with 100 pieces	8,00 €	8,00 €	100
		BS*E171		Box ECO with 500 pieces	7,02 €	35,10 €	500

UP TO YOU TO IMAGINE ALL THE POSSIBILITIES OF SYSTEMTAC 2000

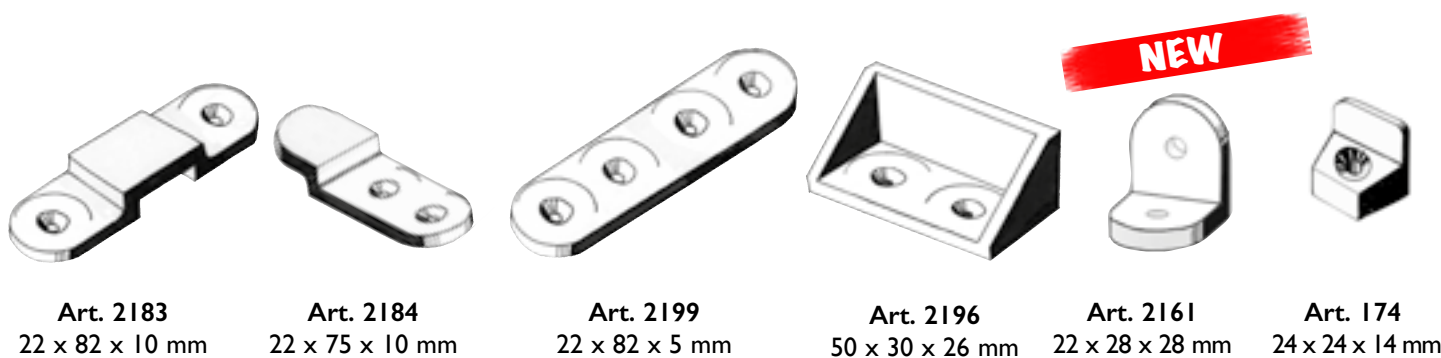

Art. 2183
22 x 82 x 10 mm

Art. 2184
22 x 75 x 10 mm

Art. 2199
22 x 82 x 5 mm

Art. 2196
50 x 30 x 26 mm

Art. 2161
22 x 28 x 28 mm

Art. 174
24 x 24 x 14 mm

Art.	Colour	Code	Description	Packaging	100/€ net	Box/€ net	Qty.
2183	Black	ST*P183	Connecting element, female, 2 holes	Box with 50 pieces	93,30 €	46,65 €	50
		ST*E183		Box ECO with 500 pieces	85,20 €	426,00 €	500
2184	Black	ST*P184	Connecting element, male, 2 holes	Box with 50 pieces	93,30 €	46,65 €	50
		ST*E184		Box ECO with 500 pieces	85,20 €	426,00 €	500
2199	Black	ST*P199	Connecting element 4 holes	Box with 100 pieces	62,60 €	62,60 €	100
		ST*E199		Box ECO with 500 pieces	54,65 €	273,25 €	500
2196	Black	ST*P196	Connecting bracket 2 holes	Box with 50 pieces	93,30 €	46,65 €	50
		ST*E196		Box ECO with 500 pieces	85,20 €	426,00 €	500
2161	Black	ST*P161	Simple bracket 2 holes	Bag with 100 pieces	58,60 €	58,60 €	100
		ST*E161		Bag ECO with 500 pieces	54,00 €	270,00 €	500
174	Brown	BU*P174	Plastic bracket	Bag with 100 pieces	9,20 €	9,20 €	100
		BU*E174		Box ECO with 500 pieces	8,00 €	40,00 €	500

A variety of connecting systems (center distance 32 mm)

Made of polyamide. To assemble, to abutt, to extend, to fix, to connect ...

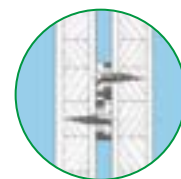
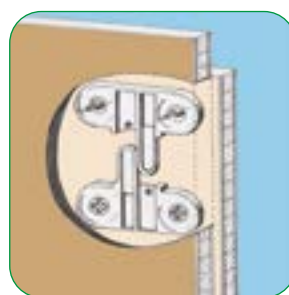
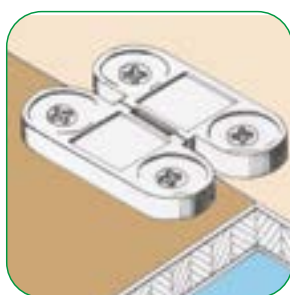

Doubling in small distance (7 mm)

POLYTAC 2185 composed of two identical pieces for flat assembly.

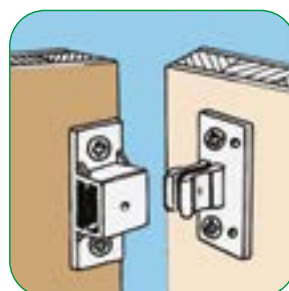

Hole distance 32 mm

POLYTAC 2186 composed of two pieces (male/female) to clip together at 90°.

POLYTAC is a new range of assembly systems which allows the quick mounting and demounting without tools for all kind of fitting, expositions, displays etc.

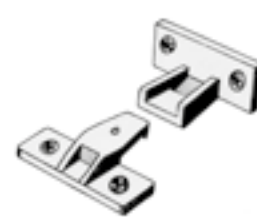
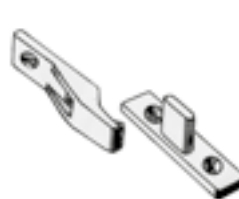
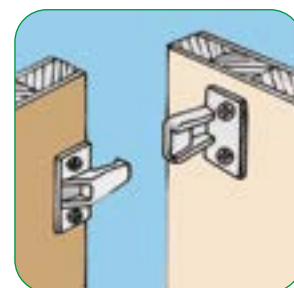
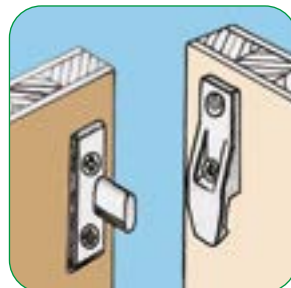

POLYTAC 2185

1 pair (2 pieces)
50 x 7 x 36 mm
Hole for screw ø 4 mm

POLYTAC 2186

1 piece 48 x 23 x 26 mm
1 piece 48 x 20 x 16 mm
Hole for screw ø 4 mm

POLYTAC 2140

1 piece 48 x 20 x 16 mm
1 piece 60 x 20 x 10 mm
Hole for screw ø 4 mm

POLYTAC 2141

1 piece 36 x 48 x 23 mm
1 piece 10 x 48 x 36 mm
Hole for screw ø 4 mm

Art	Colour	Code	Designation	Packaging	100/€net	Box/€net	Qty.
2185		PY*PI85	Binary assembling	Box 10 pairs (20 pieces)	91,50 €	18,30 €	10
		PY*EI85	Binary assembling	Box ECO 50 pairs (100 pcs)	79,70 €	79,70 €	50
2186		PY*PI86	Binary angle assembling	Box with 20 pairs	170,00 €	34,00 €	20
		PY*EI86	Binary angle assembling	Box ECO with 100 kits	146,40 €	146,40 €	100
2140		PY*PI40	Binary angle assembling	Box with 20 kits	92,00 €	18,40 €	20
		PY*EI40	Binary angle assembling	Box ECO with 100 kits	82,70 €	82,70 €	100
2141		PY*PI41	Binary angle assembling	Box with 20 kits	92,00 €	18,40 €	20
		PY*EI41	Binary angle assembling	Box ECO with 100 kits	82,70 €	82,70 €	100

Fitting system for various connections

To join several furnitures, tables, chairs, seats together...
Allow also the fastening of frames or panels on the wall.

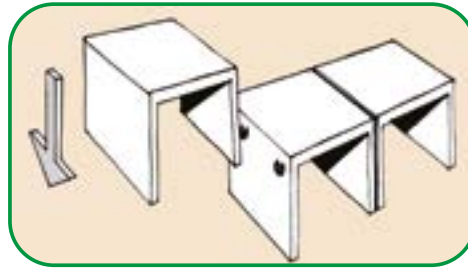

Support \varnothing 50 mm x 8 mm
3 holes TF \varnothing 4-5 mm
Foot 36 x 25 x 8 mm
2 holes TF \varnothing 4-5 mm

Art. 2100

Made of polyamide

Art.	Colour	Code	Description	Packaging	100/€net	Box/€net	Qté.
	2100	RNP2100	Relitac	Box with 25 pieces	135,20 €	33,80 €	25
		RNE2100	Relitac	Box ECO with 100 pieces	121,55 €	121,55 €	100



HINGE

Hinge 100 % Polyamide with blocking positions

Indispensable for cases, hatches, wickets, etc

Stays all 90°
Center distance
32 mm

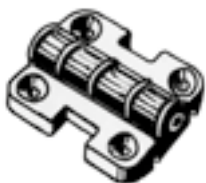

Art. 498
43 x 38 x 15 mm
4 holes for screws \varnothing 4 mm

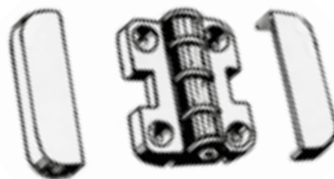

Art. 499
45 x 40 x 15 mm
4 holes for screws \varnothing 4 mm
with cover

Art.	Colour	Code	Designation	Packaging	100/€net	Box/€net	Qty.
	498	ST*C498	Hinge without cover	Bag with 4 pieces	488,75 €	19,55 €	4
	499	ST*C499	Hinge with cover	Bag with 4 pieces	635,00 €	25,40 €	4

Corners with integrated cover

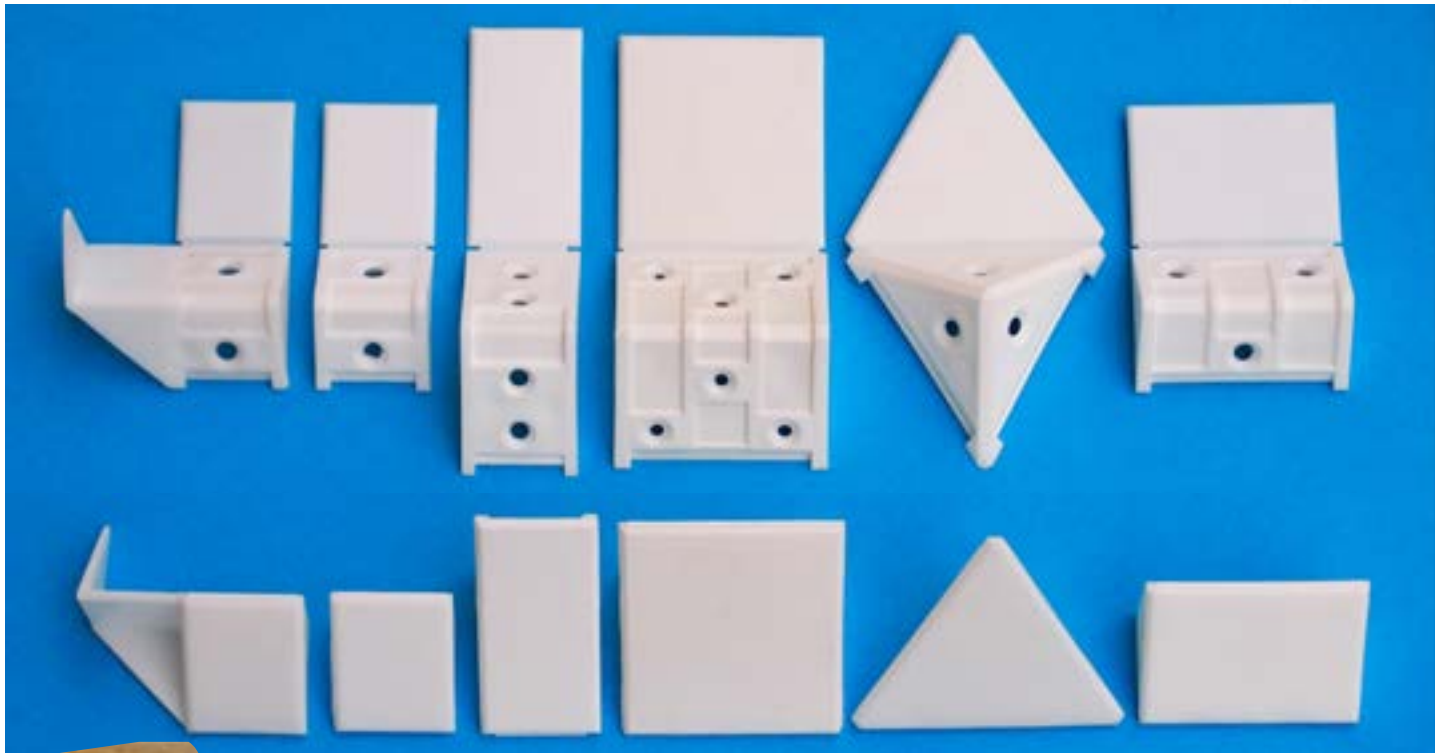

The new SYSTEMTAC 111 allows to maintain the shelf without screw and gives a perfect finish, even when the shelf is not perfectly adjusted.

SYSTEMTAC 101+
24 x 23 x 23 mm
101+ 5 colours available

SYSTEMTAC 102+
24 x 23 x 44 mm
3 screwholes ø 4 mm

SYSTEMTAC 103+
24 x 33 x 33 mm
4 screwholes ø 4 mm

SYSTEMTAC 111+
43 x 23 x 42 mm
2 screwholes ø 4 mm
sold in pairs (L+R)

SYSTEMTAC 104+
27 x 60 x 54 mm
3 screwholes ø 4 mm

SYSTEMTAC 105+
44 x 33 x 33 mm
6 screwholes ø 4 mm

Art.	Colour	Code	Designation	Packaging	100/€/w/oVAT	Box/€/w/oVAT	Qty
101+	[Image]	S+*P101	Simple corner 2 holes	Box with 100 pieces	27,15 €	27,15 €	100
	[Image]	S+*S101	Simple corner 2 holes	40 boxes with 100 pieces	21,60 €	864,00 €	4000
	[Image]	S+*E101	Couple Rivtac	Box with 25 couples	15,30 €	76,50 €	500
111	[Image]	SR*P111	Couple Rivtac	Box with 100 couples	107,80 €	26,95 €	25
	[Image]	SR*E111	Simple corner 2 holes	Box ECO with 500 pieces	92,15 €	92,15 €	100
102+	[Image]	S+*P102	Large corner 3 holes	Box with 50 pieces	48,20 €	24,10 €	50
	[Image]	S+*S102	Large corner 3 holes	40 boxes with 50 pieces	38,40 €	768,00 €	2000
	[Image]	S+*E102	Large corner 3 holes	Box ECO with 500 pieces	28,80 €	144,00 €	500
103+	[Image]	S+*P103	High corner 4 holes	Box with 50 pieces	48,20 €	24,10 €	50
	[Image]	S+*S103	High corner 4 holes	40 boxes with 50 pieces	38,40 €	768,00 €	2000
	[Image]	S+*E103	High corner 4 holes	Box ECO with 500 pieces	28,80 €	144,00 €	500
104+	[Image]	S+*P104	Triangle 3 holes	Box with 50 pieces	48,20 €	24,10 €	50
	[Image]	S+*S104	Triangle 3 holes	40 boxes with 50 pieces	38,40 €	768,00 €	2000
	[Image]	S+*E104	Triangle 3 holes	Box ECO with 500 pieces	31,90 €	159,50 €	500
105+	[Image]	S+*P105	Maxi corner 6 holes	Box with 25 pieces	64,00 €	16,00 €	25
	[Image]	S+*S105	Maxi corner 6 holes	40 boxes with 25 pieces	57,40 €	574,00 €	1000
	[Image]	S+*E105	Maxi corner 6 holes	Box ECO with 500 pieces	51,15 €	255,75 €	500



Fastening insert for fine panels

Allow the fastening on hollow PVC profiles, shutters, carpentries, fenders etc. Hole Ø 10 mm. Minimum thickness 16 mm.



Art. 179
 Ø 19,5 x 10 x 20 mm
 Hole for screw ø 3,5 - 4 mm
 Black or white



Art.	Colour	Code	Description	Packaging	100/€net	Box/€net	Qty.
179	Black	IF*P179	Fastening insert	Bag with 100 pieces	35,10 €	35,10 €	100
	White	IF*E179	Fastening insert	Box ECO with 500 pieces	31,70 €	158,50 €	500

SYSTEMTAC BASIC

A really economic product range

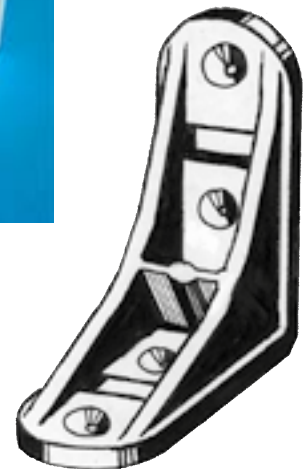
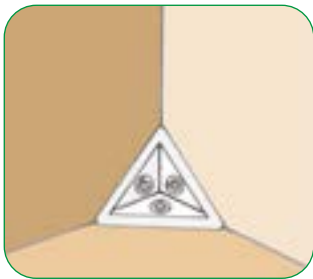

Art. 191
 24 x 24 x 16 mm

Art. 299
 ø 16 x 10 mm

Art. 192
 24 x 24 x 36 mm

Art. 194
 58 x 58 x 30 mm

Art. 193
 40 x 40 x 16 mm

Art. 252
 80 x 80 x 25 mm

Art.	Colour	Code	Description	Packaging	100/€net	Box/€net	Qty.
191	Black	STBP191	Simple corner 2 holes	Box with 400 pieces	14,00 €	56,00 €	400
	White	STBE191	Simple corner 2 holes	Box ECO with 1000 pieces	9,25 €	92,50 €	1000
192	Black	STBP192	Large corner 4 holes	Box with 150 pieces	25,07 €	37,61 €	150
	White	STBE192	Large corner 4 holes	Box ECO with 500 pieces	18,60 €	93,00 €	500
193	Black	STBP193	High corner 4 holes	Box with 100 pieces	25,05 €	25,05 €	100
	White	STBE193	High corner 4 holes	Box ECO with 500 pieces	18,60 €	93,00 €	500
194	Black	ST*P194	Triangle 3 holes	Box with 50 pieces	44,40 €	22,20 €	50
	White	ST*S194	Triangle 3 holes	40 boxes with 50 pieces	36,90 €	738,00 €	2000
	Black	ST*E194	Triangle 3 holes	Box ECO with 500 pieces	30,70 €	153,50 €	500
299	Black	PC*P299	Shelf support ø 16 mm	Box with 500 pieces	10,95 €	54,75 €	500
	White	PC*E299	Shelf support ø 16 mm	Box ECO with 1000 pieces	9,80 €	98,00 €	1000
252	Black	ST*P252	Big corner 4 holes	Box with 20 pieces	98,50 €	19,70 €	20
	White	ST*E252	Big corner 4 holes	Box ECO with 500 pieces	86,40 €	432,00 €	500

Little connecting block

For countertops, kitchen cupboards :
simple and easy fitting



Art. 118
20 x 23 x 14 mm
2 holes \varnothing 4 mm
brown or white



Art.	Colour	Code	Description	Packaging	100/€net	Box/€net	Qty.
118	White	ST*PI18	Connecting block	Bag with 100 pieces	9,20 €	9,20 €	100
	Brown	ST*EI18	Connecting block	Boîte ECO de 1000 pièces	8,00 €	80,00 €	1000

SYSTEMTAC 120

Connecting block

(Kitchen worktops, office furniture etc ...)



Art. 120
36 x 14 x 14 mm
3 holes \varnothing 4 mm
brown or white



Art.	Colour	Code	Description	Packaging	100/€net	Box/€net	Qty.
120	White	ST*PI20	Connecting block	Bag with 100 pieces	15,40 €	15,40 €	100
	Brown	ST*EI20	Connecting block	Box ECO 1000 pieces	12,30 €	123,00 €	1000

SYSTEMTAC 122

Two-block fitting with dismantling bolt

(bolt provided)

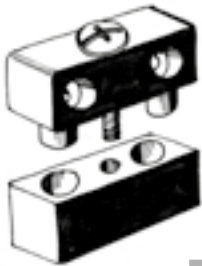

Art. 122
The 2 pieces fixed together
34 x 13 x 26 mm
4 holes for screws \varnothing 3,5 mm
In white or brown available



Art.	Colour	Code	Description	Packaging	100/€net	Box/€net	Qty.
122	White	ST*PI22	Connecting block	Box with 50 pieces	35,90 €	17,95 €	50
	Brown	ST*EI22	Connecting block	Box ECO 250 pieces	32,30 €	80,75 €	250

SYSTEMTAC 124

Snap connection

(for pelmets, plinths, false drawer, etc...)



Art. 124
The 2 pieces fixed together
33 x 12 x 16 mm
4 holes for screws \varnothing 3,5 mm
In white available



Made of polyamide

Art.	Colour	Code	Description	Packaging	Le 100/€H.T.	La Bte/€H.T.	Qté.
124	White	ST*PI24	Snap connection	Box with 50 pieces	83,80 €	41,90 €	50
	Brown	ST*EI24	Snap connection	Box ECO 250 pieces	75,50 €	188,75 €	250

Desk-tydy for cable management

- 2 diameters : 60 et 80 mm
- 5 colours
- with shut-off valve *



Art. 796
 ø 71 x 22 mm
 Hole 60 mm

Art. 797
 ø 92 x 22 mm
 Hole 80 mm

	Art.	Colour	Code	Description	Packaging	100/€net	Box/€net	Qty.
	796		PF*P796	Desk grommet Ø 60 mm	Bag with 10 pieces	123,00 €	12,30 €	10
			PF*E796	Desk grommet Ø 60 mm	Box with 50 pieces	104,30 €	52,15 €	50
	797		PF*P797	Desk grommet Ø 80 mm	Bag with 10 pieces	222,00 €	22,20 €	10
			PF*E797	Desk grommet Ø 80 mm	Box with 50 pieces	184,30 €	92,15 €	50

TACFILS 068

Cable management



TACFILS to tidy up all installations of computer, telephone, hifi, etc.



The cables can be removed and replaced easily thanks its principle of spring



Art. 068
 for 6 or 8 cables
 52 x 17 x 8 mm
 Screw hole ø 3,5 mm



	Art.	Colour	Code	Description	Packaging	100/€net	Box/€net	Qty.
	068		TF*P068	Cable clip 6-8 wires	Bag with 100 pieces	37,10 €	37,10 €	100
			TF*E068	Cable clip 6-8 wires	Box ECO 500 pieces	30,80 €	154,00 €	500

Connecting brackets for corner reinforcement

- to reinforce corners
- staple attachments etc.

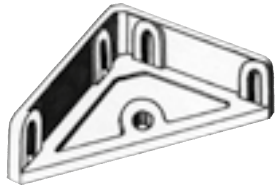

Art. 197 62 x 62 x 15 mm
Disponible en blanc ou marron

Art.	Colour	Code	Designation	Packaging	100/€net	Box/€net	Qty.
197		ST*PI97	Connecting bracket	Box with 50 pieces	103,90 €	51,95 €	50
		ST*EI97	Connecting bracket	Box ECO with 500 pieces	85,90 €	429,50 €	500

SYSTEMTAC 190

For small space fittings



Conceived for panel fitting with a very small congestion and other applications, where the place is limited.



Art. 190
9 x 20 x 30 mm
3 holes for screws \varnothing 3 mm

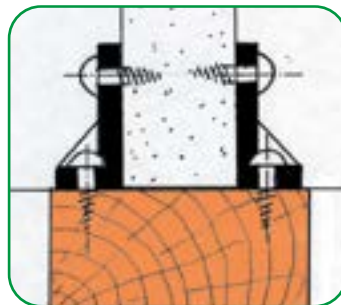

Art.	Colour	Code	Designation	Packaging	100/€net	Box/€net	Qty.
190		STBPI90	Corner 3 holes	Box with 400 pieces	34,65 €	138,60 €	400
		STBEI90	3-Loch-Winkel	Box ECO with 1000 pieces	29,70 €	297,00 €	1000

CALE TABLE



Assortment little coins

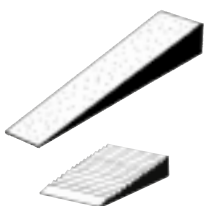

Very handy for wedging and adjusting of tables and other small furnitures (restaurants, schools, events)



Art. 1526
10 x wedges 20 x 15 x 6 mm
(5 brown et 5 white)
10 x wedges 75 x 15 x 8 mm
(5 brown et 5 white)

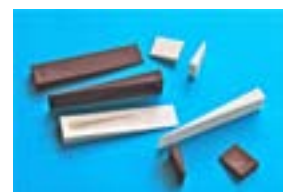

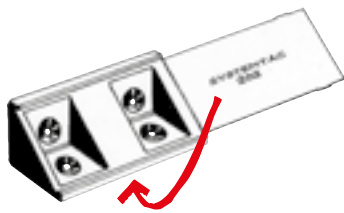

Art	Colour	Code	Designation	Packaging	100/€net	Box/€net	Qty.
1526		ACSI526	Assortment 2 x 10	Bag with 20 pieces	*	9,55 €	1
		ACX1526	Assortment 2 x 10	more than 10 bags (price 1 bag)	*	7,40 €	1

Connecting brackets with lateral closing cap



Art. 202
42 x 20 x 20 mm
Center distance de 25 mm
4 holes for screws \varnothing 3,5 / 4 mm



Art.	Colour	Code	Designation	Packaging	100/€net	Box/€net	Qty.
202		ST*P202	Large corner 4 holes	Box with 50 pieces	40,00 €	20,00 €	50
		ST*E202	Large corner 4 holes	Box ECO 500 pieces	24,60 €	123,00 €	500

SYSTEMTAC

Self support for glass shelves to screw



Art. 195
 \varnothing 11 x 9,5 mm



1 hole \varnothing 3 mm







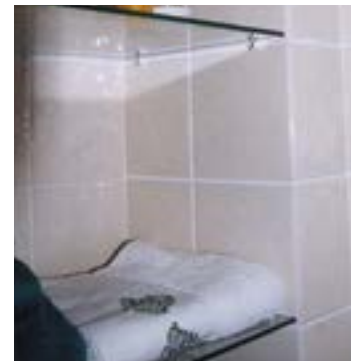
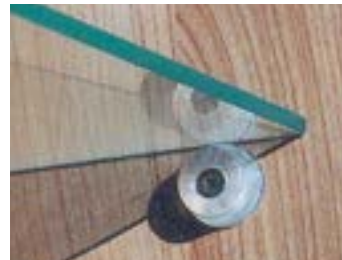

Art. 116 + Art. 116 C (cristal)

Art. 126 (Elastomer)

\varnothing 18,5 x 11 mm

1 hole for screw \varnothing 3,5 / 4 mm



Art.	Colour	Code	Designation	Packaging	100/€net	Box/€net	Qty.
195		ST*P195	Shelf support \varnothing 11 mm	Box with 500 pieces	5,40 €	27,00 €	500
		ST*E195	Shelf support \varnothing 11 mm	Box ECO 1000 pieces	4,70 €	47,00 €	1000
116		PLOP116	Shelf support \varnothing 18,5 mm	Box with 100 pieces	11,90 €	11,90 €	100
		PLOE116	Shelf support \varnothing 18,5 mm	Box ECO 1000 pieces	9,45 €	94,50 €	1000
116C		PLOP16C	Shelf support \varnothing 18,5 mm	Box with 500 pieces	14,70 €	73,50 €	500
		PLOE16C	Shelf support \varnothing 18,5 mm	Box ECO 1000 pieces	12,20 €	122,00 €	1000
126		BUCP126	Shelf support Elastomer	Box with 500 pieces	19,70 €	98,50 €	500
		BUCE126	Shelf support Elastomer \varnothing 18,5 mm	Box ECO 1000 pieces	16,45 €	164,50 €	1000

SYSTEMTAC 170

Rear panel connector





Strip with 5 pieces
1 hole for screw \varnothing 4 mm

Art. 170

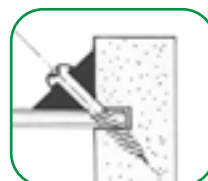
14 x 11 x 11 mm



Art.	Colour	Code	Designation	Packaging	100/€net	Box/€net	Qty.
170		STBP170	Rear panel connector	Box with 400 pieces	8,40 €	33,60 €	400
		STBE170	Rear panel connector	Box ECO 2000 pieces	5,70 €	114,00 €	2000

Fitting system for fixed or temporary connection



FITTING WITHOUT TOOLS

New connection S.C.P.32 (Licence Prunier)

- Entraxe 32 mm
- Easy to fit (no marks necessary)
- Multi-purpose : - Mantling/dismantling without locking.
- Mantling/dismantling with locking.

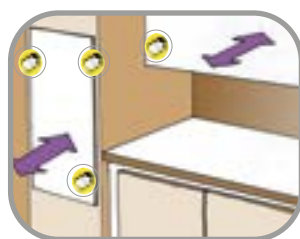
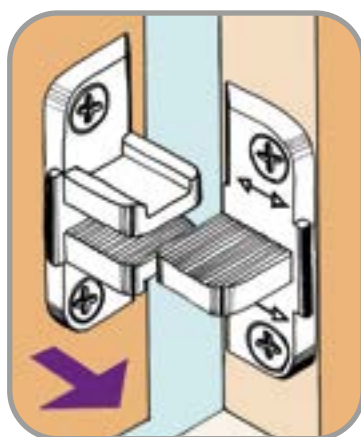
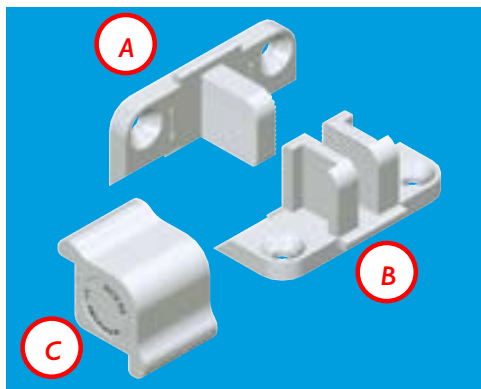

Hatches and removal panels

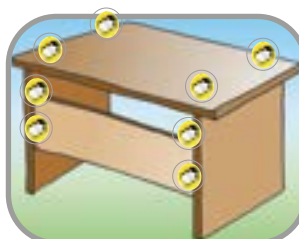

Selfmade furnitures

UP TO YOU TO INVENT THE PRODUCT WITH IT !



Art. SCP.32 42 x 21 x 21 mm
4 screwholes ø 3,5 à 4 mm - entraxe 32 mm.

Art.	Colour	Code	Designation	Packaging	100/€net	Box/€net	Qty.
SCP32		SCP*P32	Connecting fitting 3 pieces	Box with 25 pieces	76,00 €	19,00 €	25
		SCP*E32		Box ECO 500 pieces	62,85 €	314,25 €	500

TAQUET SYSTEM 32



Shelf support for predrewed panels 32 mm



Transparent shelf support for tablets in 16 mm thickness and predrewed panels, holes ø 5 mm / hole distance 32 mm

Art. S32 38 x 13 x 15 mm
hole distance 32 mm.



Art.	Colour	Code	Designation	Packaging	100/€net	Box/€net	Qty.
S32		STIPS32	Shelf support hole distance 32 mm	Box with 100 pieces	46,70 €	46,70 €	100
		STIES32		Box ECO 1000 pieces	40,60 €	406,00 €	1000



Connecting bracket in U-form



- **Very useful to all kind of fitting:** for 19 mm or 16 mm panels
- **Tough:** 4 mm thickness
- **Various:** vertical or horizontal use
- **Attractive:** the integrated cover hides the screw

The new connection for your shelves and partitions

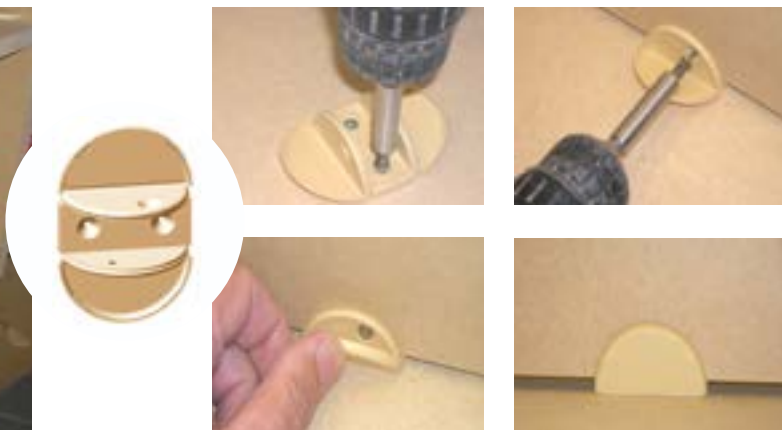

Art. M16
25 x 25 x 50 mm

For 16 mm panels



Art. M19
28 x 25 x 50 mm

For 19 mm panels

Art.	Colour	Code	Designation	Packaging	100€/net	Box/€/net	Qty.
M16	White	ST*PM16	Bracket «U» 16 mm	Box with 20 pieces	114,00 €	22,80 €	20
	Yellow	ST*EM16	Bracket «U» 16 mm	Box ECO with 100 pieces	92,60 €	92,60 €	100
M19	White	ST*PM19	Bracket «U» 19 mm	Box with 20 pieces	114,00 €	22,80 €	20
	Yellow	ST*EM19	Bracket «U» 19 mm	Box ECO with 100 pieces	92,60 €	92,60 €	100

PLINTH SEALING

Plinth sealing profile translucent

For plinths 16, 17, 18 et 19 mm.

ESSENTIAL FINISH FOR KITCHEN AND BATHROOM FITTINGS



Art. 1619
9,5 x 21 x 4,5 mm

Art.	Colour	Code	Designation	Packaging	100€/net	Box/€/net	Qty.
1619	White	RCPI1619	Plintn sealing profile bar 2,6 m	Pack with 50 bars	394,80 €	197,40 €	50
	Yellow	RCSI1619		12 boxes with 50 bars	378,55 €	2271,30 €	600

PVC edging profiles for 10 22 mm panels



THE WIDE SIDES MASC TOTALLY THE SPLINTERS OF THE SAWING AND ENSURE A PERFECT STIFFNESS.

THE FACE OF THE PROFILES 1012, 316, AND 319 IS A LITTLE DOMED SO AFTER FITTING THE FACE IS PERFECTLY FLAT

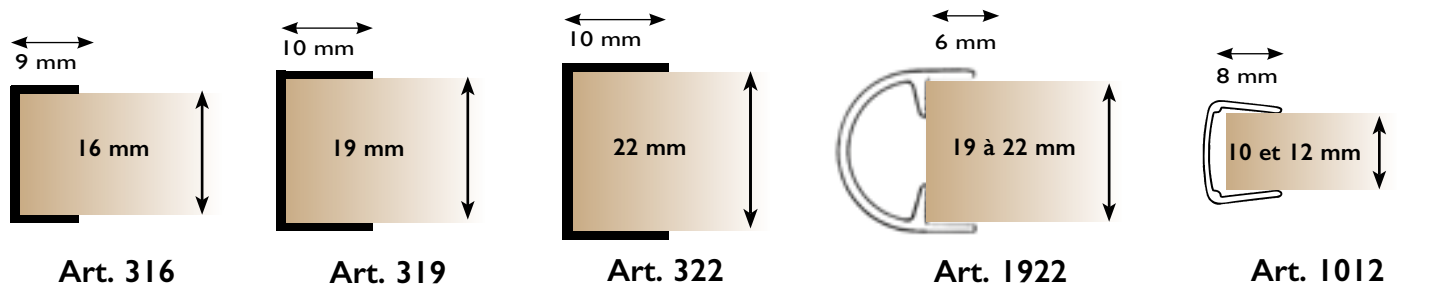
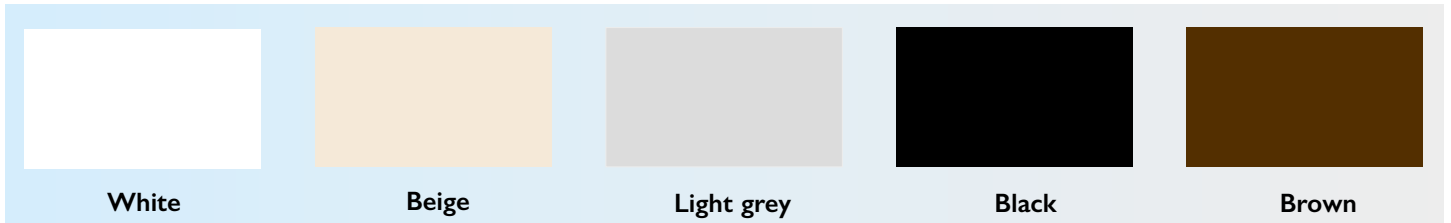
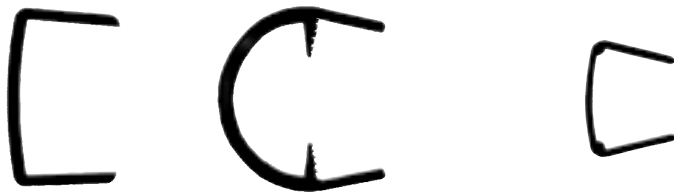

* Because of transport problems, we can sell the profiles in small quantities only when they are delivered with another pack of profiles with at least 50 bars

Art	Colour	Code	Designation	Packaging	100/€net	Box/€net	Qty.
316		RIBP316	Edging profile PVC	Pack with 50 bars	428,90 €	214,45 €	50
		RIBS316	16 mm, bar 2,6 m	10 packs with 50 bars	373,20 €	1866,00 €	500
316C		RI*PI6C	Edging profile PVC	Pack with 50 bars	519,80 €	259,90 €	50
		RI*B16C	16 mm, bar 2,6 m	unity, but 10 bars minimum		7,15 €	1 *
319		RIBP319	Edging profile PVC	Pack with 50 bars	498,70 €	249,35 €	50
		RIBS319	19 mm, bar 2,6 m	10 packs with 50 bars	397,50 €	1987,50 €	500
319C		RI*PI9C	Edging profile PVC	Pack with 50 bars	591,20 €	295,60 €	50
		RI*B19C	19 mm, bar 2,6 m	unity, but 10 bars minimum		8,40 €	1 *
322		RIBP322	Edging profile PVC	Pack with 50 bars	531,60 €	265,80 €	50
		RIBS322	22 mm, bar 2,6 m	10 packs with 50 bars	449,90 €	2249,50 €	500
1922		RBPI922	Edging profile PVC	Pack with 50 bars	746,00 €	373,00 €	50
		RBSI922	19-22 mm, bar 2,6 m	6 packs with 50 bars	596,80 €	1790,40 €	300
1922C		R*PI922	Edging profile PVC	Pack with 50 bars	834,30 €	417,50 €	50
		R*B1922	19-22 mm, bar 2,6 m	unity, but 10 bars minimum		11,70 €	1 *
1012		RBPI012	Edging profile PVC	Pack with 50 bars	346,80 €	173,40 €	50
		RBSI012	10-12 mm, bar 2,6 m	10 packs with 50 bars	303,70 €	1518,50 €	500

Connecting and panel profiles

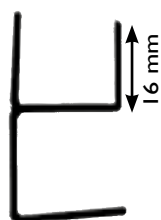

Art. 16AV
19AV

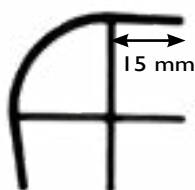

Art. 19AR



Art. 19CL

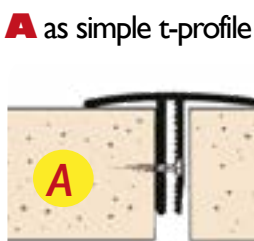

A

B as connecting profile for 16 or 19 mm panels

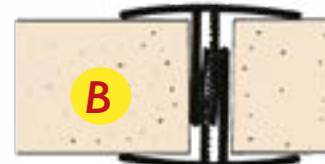

B



Art. 04AV

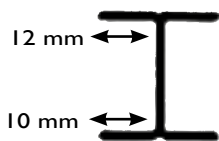

Art. 1919



Art. 0808



Art. 0404



Art. 3009



Art 2014

ALL OUR PROFILES ARE 2,60 m LONG

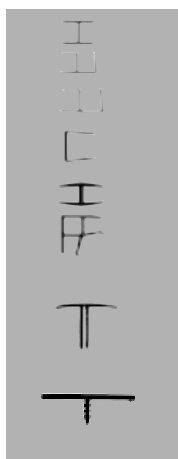

Art.	Colour	Code	Designation	Packaging	100/€net	Box/€net	Qty.
1919		HBPI919	H profile PVC 19 x 19 mm	Pack with 25 bars	822,00 €	205,50 €	25
16AV		RAVBPI16	Profile 90° PVC 16 mm	Pack with 25 bars	786,00 €	196,50 €	25
19AV		RAVBPI19	Profile 90° PVC 19 mm	Pack with 25 bars	822,00 €	205,50 €	25
19CL		RCLBPI19	U profile PVC 19 mm	Pack with 25 bars	676,20 €	169,05 €	25
0404		HBP0404	H profile PVC 4 x 4 mm	Pack with 25 bars	432,40 €	216,20 €	50
0808		HBP0808	Profil H PVC 8 x 8 mm	Pack with 25 bars	722,70 €	361,35 €	50
04AV		RAVBPO4	Profile 90° PVC 4 mm	Pack with 25 bars	696,50 €	348,25 €	50
19AR		RARBPI19	Profile round PVC 19mm	Pack with 25 bars	1741,00 €	435,25 €	25
2014		TBP2014	T-profile PVC 20 x 14 mm length 2,6 m	Pack with 50 bars	414,20 €	207,10 €	50
		TBB2014		Unity, but 10 bars minimum		5,85 €	1*
3009		TBP3009	T-profile PVC 30 x 9 mm length 2,6 m	Pack with 50 bars	414,20 €	207,10 €	50
		TBB3009		Unity, but 10 bars minimum		5,85 €	1*

Angle profiles

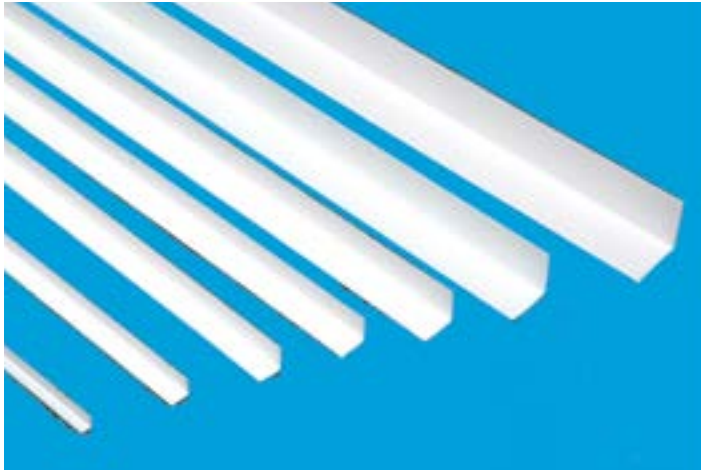

* Because of transport problems, we can sell the profiles in small quantities only when they are delivered with another pack of profiles with at least 50 bars.

Flat bars

Art. 30PL

Art. 40PL

Equal corners

Art. 1010

Art. 1515

Art. 2020

Art. 2525

Art. 3030

Art. 4040

Art. 5050

NEW

**Black corner
20 x 20 et 30 x 30**

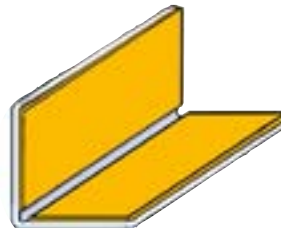

Corner 20 x 20 self adhesive

Art.	Colour	Code	Designation	Packaging	100/€ _{net}	Box/€ _{net}	Qty.
1010		LBP1010	Profil L PVC 10 x 10 mm en barre de 2,6 m	Paquet de 50 barres	195,00 €	97,50 €	50
		LBB1010		À la barre / 10 barres minimum		2,80 €	1
1515		LBP1515	Profil L PVC 15 x 15 mm en barre de 2,6 m	Paquet de 50 barres	285,70 €	142,85 €	50
		LBB1515		À la barre / 10 barres minimum		4,25 €	1
2020		LBP2020	Profil L PVC 20 x 20 mm en barre de 2,6 m	Paquet de 50 barres	376,90 €	188,45 €	50
		LBB2020		À la barre / 10 barres minimum		5,60 €	1
		LNP2020		Paquet de 50 barres	583,90 €	291,95 €	50
2525		LBP2525	Profil L PVC 25 x 25 mm en barre de 2,6 m	Paquet de 50 barres	417,70 €	208,85 €	50
		LBB2525		À la barre / 10 barres minimum		5,85 €	1
3030		LBP3030	Profil L PVC 30 x 30 mm en barre de 2,6 m	Paquet de 50 barres	460,40 €	230,20 €	50
		LBB3030		À la barre / 10 barres minimum		6,40 €	1
		LNP3030		Paquet de 50 barres	694,90 €	347,45 €	50
4040		LBP4040	Profil L PVC 40 x 40 mm en barre de 2,6 m	Paquet de 50 barres	512,20 €	256,10 €	50
		LBB4040		À la barre / 10 barres minimum		7,20 €	1
5050		LBP5050	Profil L PVC 50 x 50 mm en barre de 2,6 m	Paquet de 25 barres	972,80 €	243,20 €	25
		LBB5050		À la barre / 10 barres minimum		12,65 €	1
20AD		LBP20AD	Profil L adhésif 20 x 20 mm en barre de 2,6 m	Paquet de 25 barres	1137,20 €	284,30 €	25
		LBB20AD		À la barre / 10 barres minimum		12,85 €	1
30PL		PBP30PL	Profil plat PVC 30 mm en barre de 2,6 m	Paquet de 50 barres	464,80 €	232,40 €	50
		PBB30PL		À la barre / 10 barres minimum		6,55 €	1
40PL		PBP40PL	Profil plat PVC 40 mm en barre de 2,6 m	Paquet de 50 barres	522,40 €	261,20 €	50
		PBB40PL		À la barre / 10 barres minimum		7,45 €	1

* Price for 1 bar



Finishing profiles



Varying angle profile

* Because of transport problems, we can sell the profiles in small quantities only when they are delivered with another pack of profiles with at least 50 bars

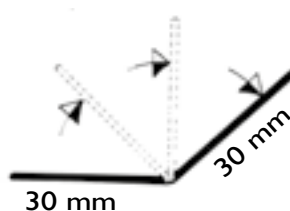

Art. 30VA

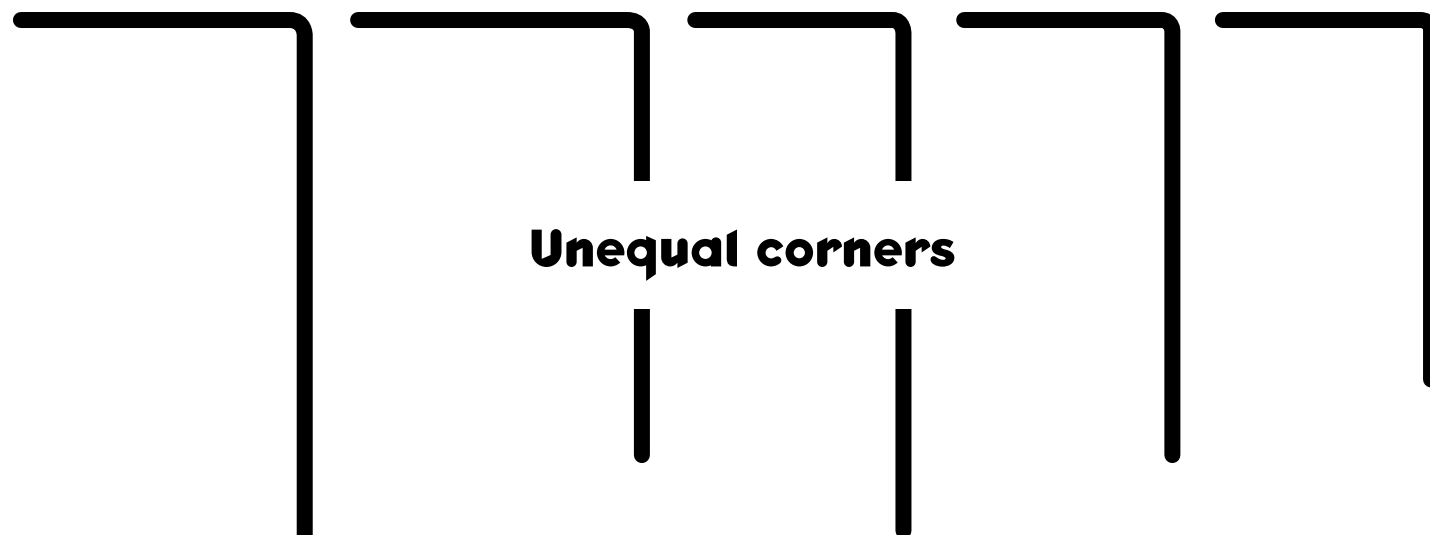

Unequal corners

Art. 4080
40 x 80 x 2600 mm

Art. 4060
40 x 60 x 2600 mm

Art. 3070
30 x 70 x 2600 mm

Art. 3060
30 x 60 x 2600 mm

Art. 3050
30 x 50 x 2600 mm

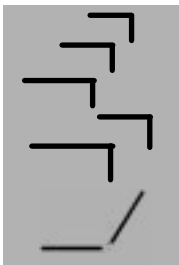

Art.	Colour	Code	Designation	Packaging	100/€net	Box/€net	Qty.
3050		LBP3050	Corner L PVC 30 x 50 mm	Pack with 50 bars	665,40 €	166,35 €	50
3060		LBP3060	Corner L PVC 30 x 60 mm	Pack with 50 bars	788,40 €	197,10 €	50
3070		LBP3070	Corner L PVC 30 x 70 mm	Pack with 50 bars	911,20 €	227,80 €	50
4060		LBP4060	Corner L PVC 40 x 60 mm	Pack with 50 bars	911,20 €	227,80 €	50
4080		LBP4080	Corner L PVC 40 x 80 mm	Pack with 50 bars	1059,20 €	264,80 €	50
30VA		LVABP30	Corner L PVC 30 x 30 mm	Pack with 50 bars	956,40 €	238,10 €	25
		LVABB30	variable, barre de 2,6 m	unity, but 10 bars minimum		13,50 €	1

Price label adhesive cutted

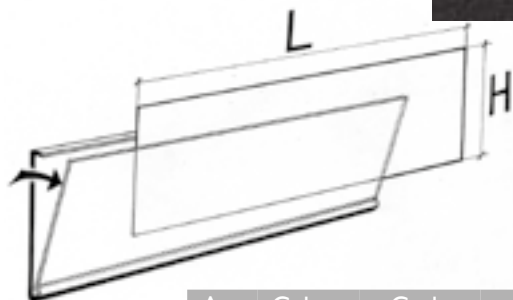

Art.	Colour	Code	Designation	Packaging	100/€net	Box/€net	Qty.
1860		PEP1860	Price label PVC adhesive H = 18 x L = 60 mm	Bag with 100 pieces	89,20 €	89,20 €	100
		PES1860		more than 5 bags	79,65 €	79,65 €*	100
1890		PEP1890	Price label PVC adhesive H = 18 x L = 90 mm	Bag with 100 pieces	138,15 €	138,15 €	100
		PES1890		more than 5 bags	127,70 €	127,70 €*	100
3010		PEP3010	Price label PVC adhesive H = 30 x L = 100 mm	Bag with 100 pieces	161,35 €	161,35 €	100
		PES3010		more than 5 bags	149,70 €	149,70 €*	100
3015		PEP3015	Price label PVC adhesive H = 30 x L = 150 mm	Bag with 100 pieces	222,70 €	222,70 €	100
		PES3015		more than 5 bags	209,80 €	209,80 €*	100
4010		PEP4010	Price label PVC adhesive H = 40 x L = 100 mm	Bag with 100 pieces	203,20 €	101,60 €	50
		PES4010		more than 5 bags	185,10 €	92,55 €*	50
4015		PEP4015	Price label PVC adhesive H = 40 x L = 150 mm	Bag with 100 pieces	284,30 €	142,15 €	50
		PES4015		more than 5 bags	250,20 €	125,10 €*	50

* Le sachet

Price label profiles in bars

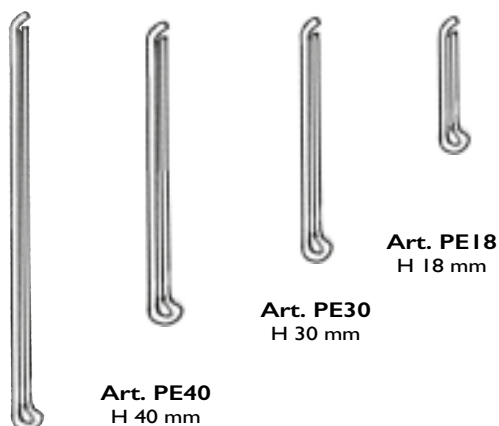

These price labels are available in cut length : 100 cm and 130 cm

Art. PE60
H 60 mm



Art.	Colour	Code	Designation	Packaging	100/€net	Box/€net	Qty.
PE18		PEB1800	Bar 1000 mm H = 18	Box with 100 bars	333,65 €	333,65 €	100
		PEB1833	Bar 1330 mm H = 18	Box with 100 bars	442,75 €	442,75 €	100
PE30		PEB3000	Bar 1000 mm H = 30	Box with 100 bars	338,35 €	338,35 €	100
		PEB3033	Bar 1330 mm H = 30	Box with 100 bars	449,60 €	449,60 €	100
PE40		PEB4000	Bar 1000 mm H = 40	Box with 100 bars	400,10 €	400,10 €	100
		PEB4033	Bar 1330 mm H = 40	Box with 100 bars	531,00 €	531,00 €	100
PE60		PEB6000	Bar 1000 mm H = 60	Box with 100 bars	484,15 €	484,15 €	100
		PEB6033	Bar 1330 mm H = 60	Box with 100 bars	643,70 €	643,70 €	100

Edging profile with price label function cutted

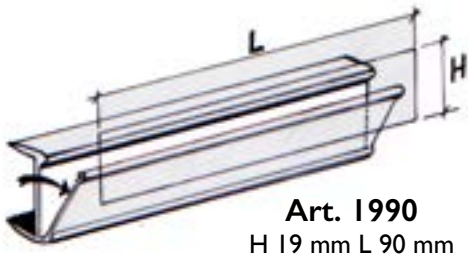

Art. 1990
H 19 mm L 90 mm

- Edging profile for 19 mm panels
- For labels with max. 18 mm height



Art.	Colour	Code	Designation	Packaging	100/€net	Box/€net	Qty.
1990		REPI990	Rivtiquette 90 mm	Bag with 100 pieces	82,70 €	82,70 €	100
		RESI990	Rivtiquette 90 mm	More than 5 bags	76,75 €	76,75 €	100

Edging profile with price label function in bars



Art. RPE19
H 19 mm

- Edging profile for 19 mm panels
- For labels with max. 18 mm height



Art.	Colour	Code	Designation	Packaging	100/€net	Box/€net	Qty.
RPE19		RETBPI9	Rivtiquette bar 2,6 m	Pack with 25 bars	848,00 €	212,00 €	25

PRICE LABELS

Decorative price label

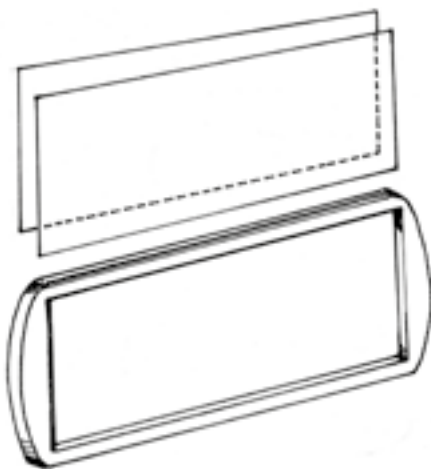

Art. 022
57 x 22 x 4 mm

white

Art. 030
78 x 30 x 4 mm

black

Art. 035
100 x 35 x 4 mm



Art.	Colour	Code	Designation	Packaging	100/€w/oVAT	100/€w/oVAT	Qty.
022		PEAP022	Price label 57 x 22 mm	Bag with 10 pieces	472,00 €	47,20 €	10
030		PEAP030	Price label 78 x 30 mm	Bag with 10 pieces	535,50 €	53,55 €	10
035		PEAP035	Price label 100 x 35 mm	Bag with 10 pieces	619,00 €	61,90 €	10
022		PE*P022	Price label 57 x 22 mm	Bag with 10 pieces	218,00 €	21,80 €	10
030		PE*P030	Price label 78 x 30 mm	Bag with 10 pieces	278,50 €	27,85 €	10
035		PE*P035	Price label 100 x 35 mm	Bag with 10 pieces	336,00 €	33,60 €	10

Key ring pendant

2 Packagings :

1

**Bag with 100 pieces
6 colours mixed**

2

**Box with 6 bags
each with 100 pieces uni color**



Art. P100

H 21 x L 57 mm

with a white label and clear protection

Yellow, blue, green, black, white and red

Code * = (J) (B) (V) (N) (W) (R)

Art	Colour	Code	Designation	Packaging	100/€net	Box/€net	Qty.
P100		PECPI00	Key ring	Box 100 pieces (6 colours mixed)	38,45 €	38,45 €	100
		PC*P100	Key ring	Box 100 pieces (one colour)	38,45 €	38,45 €	100
		PECEI00	Key ring	6 boxes (1 of each colour)	32,60 €	195,60 €	600

KEY MARKER

Accessories for keys with a dual function



Art. 810

ø 29 mm x 4 mm

identification

by the colour of the ring

Protection

for your pockets

Art	Colour	Code	Designation	Packaging	100/€net	Box/€net	Qty.
810		MC*P810	Key marker	50 pieces uni	106,90 €	53,45 €	50
		MCCP810	Key marker	50 pieces mixed	106,90 €	53,45 €	50

UNIVERSAL CLIP 173

Universal fastening for small objects



3 fitting possibilities

- ➔ to nail
- ➔ to screw
- ➔ to staple

Art. 173

4,5 x 20 x 60 mm



Art	Colour	Code	Designation	Packaging	100/€net	Box/€net	Qty.
173		AU*P173	Universal clip	Box with 100 pieces	33,85 €	33,85 €	100
		AU*E173	Universal clip	Box ECO with 500 pieces	27,50 €	137,50 €	500

The bracket SYSTEMTAC 01 becomes decoration

TAC BOULE
is composed of 2 pieces



Screw the
SYSTEMTAC 01



Clip-on the
decorative
cover



A very
stilish
fitting-out

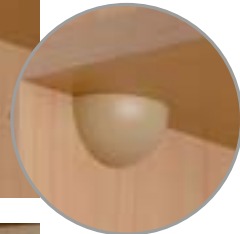

TAC BOULE is in 5 colours available



White Grey Camel Brown Black

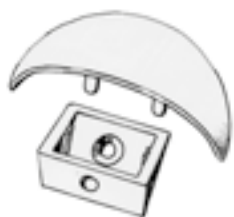

Art. 05 C
25 x 25 x 50 mm

Art.	Colour	Code	Designation	Packaging	100/€ net	Box/€net	Qty.
05C	[Color swatches]	ST*P05C	Systemtac 01 with cover 050	Box with 20 pieces	82,00 €	16,40 €	20
		ST*E05C		Box ECO with 100 pieces	74,75 €	74,75 €	100
050	[Color swatches]	ST*E050	Cover 050	Box ECO with 100 pieces	68,75 €	68,75 €	100

RECESSED PULLS

Sliding door handles



Art. 8030
83 x 29 x 8 mm



Art. C055
ø 55 x 8 mm
Trou de ø 46 mm



Art. C030
ø 30 x 8 mm
Trou de ø 25 mm



Art.	Colour	Code	Designation	Packaging	100/€net	Box/€net	Qty.
8030	[Color swatch]	CBP8030	Handle 83 x 29 mm white	Bag with 10 pieces	170,50 €	17,05 €	10
C030	[Color swatch]	CBPC030	Handle ø 30 mm white	Bag with 10 pieces	109,00 €	10,90 €	10
C055	[Color swatch]	CBPC055	Handle ø 55 mm white	Bag with 10 pieces	147,50 €	14,75 €	10
8030	[Color swatch]	CAP8030	Handle 83 x 29 mm tone alu	Bag with 10 pieces	410,50 €	41,05 €	10
C030	[Color swatch]	CAPC030	Handle ø 30 mm tone alu	Bag with 10 pieces	354,00 €	35,40 €	10
C055	[Color swatch]	CAPC055	Handle ø 55 mm tone alu	Bag with 10 pieces	382,00 €	38,20 €	10

Butoir transparent auto-adhésif



SOUND DAMPENING • TRANSPARENT • NON-SKID

- | | | | | |
|--|---|---|--|---|
| SERIES 530 | SERIES 540 | SERIES 550 | SERIES 560 | 530 S |
|  |  |  |  |  |
| DOMED | FLAT | SQUARE | HOLLOW | EXTRA SOUNDLESS |

NEW



Réf. 530GS SOFT
 ø 9,5 mm Hauteur 4,6 mm
 Dôme 3,6 mm



This new dampening bumper is designed with «flexible softness» to absorb energy from closing cabinet doors and drawers.
 Hardness Shore A65 600% Elongation

Bi-hardness door bumper

to fix into a hole of ø 5 mm



Art. 580
 ø 9 x 8 mm
 Bumper 2,5 mm
 Grey or clair

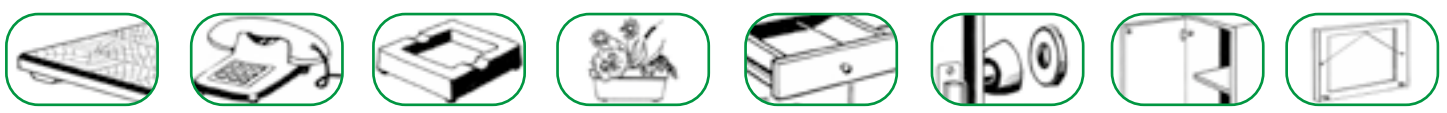
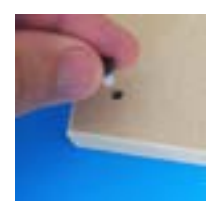

SILENTAC 530

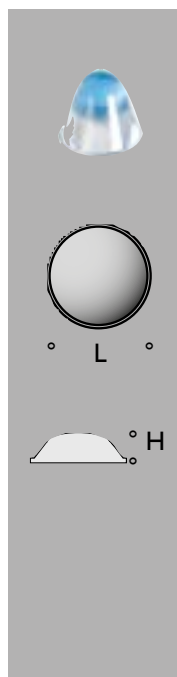

Art.	Colour	Code	Designation	Packaging	100/€net	Box/€net	Qty.
530A		BUS530A	Self-stick bumper silentac ø 7 x 1,5 mm	10 bags with 64 bumpers	8,75 €	56,00 €	640
		BUE530A		Box ECO with 2560 bumpers	6,09 €	155,90 €	2560
530B		BUS530B	Self-stick bumper silentac ø 9 x 2 mm	10 sachets de 100 butoirs	10,44 €	104,40 €	1000
		BUE530B		Box ECO with 2800 bumpers	7,50 €	210,00 €	2800
530C		BUS530C	Self-stick bumper silentac ø 11 x 5 mm	10 bags with 50 bumpers	16,89 €	84,45 €	500
		BUE530C		Box ECO with 1400 bumpers	13,95 €	195,30 €	1400
530D		BUP530D	Self-stick bumper silentac ø 16 x 8 mm	Bag with 64 bumpers	41,01 €	26,25 €	64
		BUE530D		Box ECO with 640 bumpers	32,68 €	209,15 €	640
530E		BUP530E	Self-stick bumper silentac ø 18 x 9,5 mm	Bag with 49 bumpers	60,92 €	29,85 €	49
		BUE530E		Box ECO with 343 bumpers	47,71 €	163,65 €	343
530F		BUP530F	Self-stick bumper silentac ø 18 x 14 mm	Bag with 48 bumpers	84,16 €	40,40 €	48
		BUE530F		Box ECO with 196 bumpers	64,21 €	125,85 €	196
530S		BUP530S	Self-stick bumper silentac ø 12 x 4 mm	Bag with 100 bumpers	21,65 €	21,65 €	100
		BUE530S		Box ECO with 1000 bumpers	17,18 €	171,80 €	1000
530G		BUP530G	Self-stick bumper silentac ø 10 x 3 mm	Bag with 144 bumpers	14,34 €	20,65 €	144
		BUE530G		Box ECO with 1440 bumpers	11,91 €	171,50 €	1440
530GS		BP530GS	Self-stick bumper silentac ø 9,6 x 4,6 mm	Bag with 144 bumpers	14,34 €	20,65 €	144
		BE530GS		Box ECO with 1440 bumpers	11,91 €	171,50 €	1440

SILENTAC 540

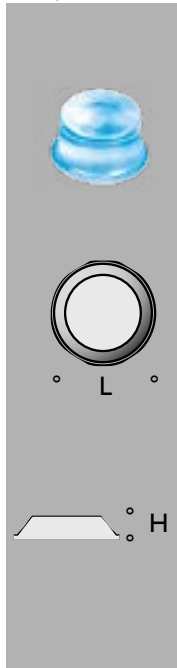

Art.	Colour	Code	Designation	Packaging	100/€net	Box/€net	Qty.
540A		BUP540A	Self-stick bumper silentac ø 13 x 1,5 mm	Bag with 100 bumpers	14,50 €	14,50 €	100
		BUE540A		Box ECO with 1000 bumpers	11,74 €	117,40 €	1000
540AL large		BP540AL	Self-stick bumper silentac ø 19 x 2 mm	Bag with 42 bumpers	44,41 €	18,65 €	42
		BE540AL		Box ECO with 840 bumpers	36,19 €	304,00 €	840
540B		BUP540B	Self-stick bumper silentac ø 13 x 3,5 mm	Bag with 100 bumpers	19,55 €	19,55 €	100
		BUE540B		Box ECO with 1000 bumpers	15,82 €	158,20 €	1000
540BP		BP540BP	Self-stick bumper silentac ø 9,5 x 3 mm	Bag with 150 bumpers	14,23 €	21,35 €	150
		BE540BP		Box ECO with 1500 bumpers	11,37 €	170,55 €	1500
540BC creux		BP540BC	Self-stick bumper silentac ø 13 x 3,5 mm	Bag with 100 bumpers	19,55 €	19,55 €	100
		BE540BC		Box ECO with 1000 bumpers	15,82 €	158,20 €	1000
540C		BUP540C	Self-stick bumper silentac ø 19 x 4 mm	Bag with 49 bumpers	45,82 €	22,45 €	49
		BUE540C		Box ECO with 490 bumpers	37,55 €	184,00 €	490
540D		BUP540D	Self-stick bumper silentac ø 9,5 x 5 mm	Bag with 100 bumpers	19,55 €	19,55 €	100
		BUE540D		Box ECO with 1000 bumpers	15,82 €	158,20 €	1000
540E		BUP540E	Self-stick bumper silentac ø 13 x 6 mm	Bag with 100 bumpers	26,90 €	26,90 €	100
		BUE540E		Box ECO with 1000 bumpers	21,50 €	215,00 €	1000
540F		BUP540F	Self-stick bumper silentac ø 16 x 10 mm	Bag with 64 bumpers	38,05 €	24,35 €	64
		BUE540F		Box ECO with 640 bumpers	30,61 €	195,90 €	640

SILENTAC 550

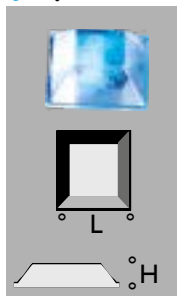

Art.	Colour	Code	Designation	Packaging	100/€net	Box/€net	Qty.
550A		BUP550A	Self-stick bumper silentac 10 x 10 x 2,5 mm	Bag with 121 bumpers	14,13 €	17,10 €	121
		BUE550A		Box ECO with 1210 bumpers	11,57 €	140,00 €	1210
550B		BUP550B	Self-stick bumper silentac 13 x 13 x 3 mm	Bag with 100 bumpers	18,30 €	18,30 €	100
		BUE550B		Box ECO with 1000 bumpers	14,70 €	147,00 €	1000
550C		BUP550C	Self-stick bumper silentac 13 x 13 x 6 mm	Bag with 100 bumpers	29,75 €	29,75 €	100
		BUE550C		Box ECO with 1000 bumpers	23,80 €	238,00 €	1000
550D		BUP550D	Self-stick bumper silentac 20 x 20 x 8 mm	Bag with 49 bumpers	42,96 €	21,05 €	49
		BUE550D		Box ECO with 1000 bumpers	33,71 €	165,18 €	490

SILENTAC 560

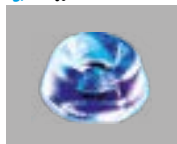

Art.	Colour	Code	Designation	Packaging	100/€net	Box/€net	Qty.
560A		BUP560A	Self-stick bumper silentac ø 22 x 10 mm	Bag with 36 bumpers	67,21 €	24,20 €	36
		BUE560A		Box ECO with 180 bumpers	54,72 €	98,50 €	180
560B		BUP560B	Self-stick bumper silentac ø 46 x 16 mm	Bag with 1 bumpers	470,00 €	4,70 €	1
		BUE560B		Box ECO with 50 bumpers	367,20 €	183,60 €	50

SILENTAC 580



Art.	Colour	Code	Designation	Packaging	100/€net	Bag/€H.net	Qty.
580		BU*P580	Self-stick bumper silentac ø 9 x 8 mm	Bag with 100 pieces	11,25 €	11,25 €	100
		BU*E580		Bag with 500 pieces	9,40 €	47,00 €	500

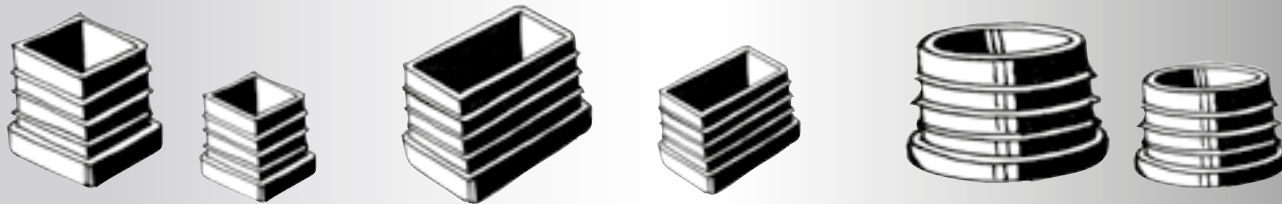

only in black available

Bouchons à ailettes

- facilité de montage
- maintien parfait

Réf. 650
pour tubes carrés



Réf. 660
pour tubes rectangulaires



Réf. 670
pour tubes ronds



Art..	Colour	Code	Designation	Packaging	100/€net	Box/€net	Oty.
650A		ECE650A	Square insert for tube 12 x 12 mm	Bag with 200 inserts	11,00 €	22,00 €	200
650B		ECE650B	Square insert for tube 14 x 14 mm	Bag with 200 inserts	11,90 €	23,80 €	200
650C		ECE650C	Square insert for tube 16 x 16 mm	Bag with 200 inserts	13,00 €	26,00 €	200
650D		ECE650D	Square insert for tube 18 x 18 mm	Bag with 200 inserts	20,50 €	41,00 €	200
650E		ECE650E	Square insert for tube 20 x 20 mm	Bag with 200 inserts	20,80 €	41,60 €	200
650F		ECE650F	Square insert for tube 25 x 25 mm	Bag with 200 inserts	28,90 €	57,80 €	200
650G		ECE650G	Square insert for tube 30 x 30 mm	Bag with 100 inserts	39,20 €	39,20 €	100
650H		ECE650H	Square insert for tube 35 x 35 mm	Bag with 100 inserts	56,05 €	56,05 €	100
650I		ECE650I	Square insert for tube 40 x 40 mm	Bag with 100 inserts	64,60 €	64,60 €	100
650J		ECE650J	Square insert for tube 50 x 50 mm	Bag with 100 inserts	91,80 €	91,80 €	100

Art..	Colour	Code	Designation	Packaging	Le 100/€H.T.	La Bte/€H.T.	Oty.
660A		ERE660A	Insert for tube 15 x 20 mm	Bag with 200 inserts	17,05 €	34,10 €	200
660B		ERE660B	Insert for tube 15 x 25 mm	Bag with 200 inserts	18,90 €	37,80 €	200
660C		ERE660C	Insert for tube 15 x 30 mm	Bag with 200 inserts	25,60 €	51,20 €	200
660D		ERE660D	Insert for tube 20 x 30 mm	Bag with 200 inserts	29,05 €	58,10 €	200
660E		ERE660E	Insert for tube 20 x 35 mm	Bag with 200 inserts	34,05 €	68,10 €	200
660F		ERE660F	Insert for tube 20 x 40 mm	Bag with 200 inserts	40,90 €	81,80 €	200
660G		ERE660G	Insert for tube 20 x 50 mm	Bag with 200 inserts	49,25 €	98,50 €	200
660H		ERE660H	Insert for tube 20 x 60 mm	Bag with 200 inserts	44,25 €	88,50 €	200
660I		ERE660I	Insert for tube 30 x 40 mm	Bag with 100 inserts	64,55 €	64,55 €	100
660J		ERE660J	Insert for tube 30 x 50 mm	Bag with 100 inserts	66,25 €	66,25 €	100

Art..	Colour	Code	Designation	Packaging	Le 100/€H.T.	La Bte/€H.T.	Oty.
670A		EOE670A	Insert for tube ø 16 mm	Bag with 200 inserts	16,75 €	33,50 €	200
670B		EOE670B	Insert for tube ø 18 mm	Bag with 200 inserts	20,50 €	41,00 €	200
670C		EOE670C	Insert for tube ø 20 mm	Bag with 200 inserts	22,20 €	44,40 €	200
670D		EOE670D	Insert for tube ø 22 mm	Bag with 200 inserts	23,70 €	47,40 €	200
670E		EOE670E	Insert for tube ø 25 mm	Bag with 200 inserts	25,60 €	51,20 €	200
670F		EOE670F	Insert for tube ø 28 mm	Bag with 100 inserts	29,00 €	29,00 €	100
670G		EOE670G	Insert for tube ø 30 mm	Bag with 100 inserts	30,50 €	30,50 €	100
670H		EOE670H	Insert for tube ø 35 mm	Bag with 100 inserts	39,20 €	39,20 €	100
670 I		EOE670I	Insert for tube ø 40 mm	Bag with 100 inserts	51,00 €	51,00 €	100



only in black available

Tube protection

- finishing for round tubes and corners
- protection against choc, dust and corrosion

Art. 680
Outside fitting foot



Art. 700
Corner insert



Art.	Colour	Code	Designation	Packaging	100/€net	Box/€net	Qty.
	680A	EEE680A	Foot for tube ø 10 mm	Bag with 200 pieces	7,00 €	14,00 €	200
	680B	EEE680B	Foot for tube ø 12 mm	Bag with 200 pieces	8,60 €	17,20 €	200
	680C	EEE680C	Foot for tube ø 14 mm	Bag with 200 pieces	11,90 €	23,80 €	200
	680D	EEE680D	Foot for tube ø 16 mm	Bag with 200 pieces	13,80 €	27,60 €	200
	680E	EEE680E	Foot for tube ø 18 mm	Bag with 200 pieces	19,30 €	38,60 €	200
	680F	EEE680F	Foot for tube ø 19 mm	Bag with 200 pieces	22,40 €	44,80 €	200
	680G	EEE680G	Foot for tube ø 20 mm	Bag with 200 pieces	23,80 €	47,60 €	200
	680H	EEE680H	Foot for tube ø 22 mm	Bag with 200 pieces	31,35 €	62,70 €	200
	680I	EEE680I	Foot for tube ø 25 mm	Bag with 200 pieces	39,20 €	78,40 €	200
	680J	EEE680J	Foot for tube ø 28 mm	Bag with 200 pieces	42,45 €	84,90 €	200
680K	EEE680K	Foot for tube ø 30 mm	Bag with 200 pieces	53,85 €	107,70 €	200	

Art.	Colour	Code	Designation	Packaging	100/€net	Box/€net	Qty.
	700A	BAP700A	Corner insert 25 x 25 mm	Bag with 200 pieces	42,25 €	8,45 €	20
	700B	BAP700B	Corner insert 30 x 30 mm	Bag with 200 pieces	45,00 €	9,00 €	20
	700C	BAP700C	Corner insert 35 x 35 mm	Bag with 200 pieces	49,75 €	9,95 €	20
	700D	BAP700D	Corner insert 40 x 40 mm	Bag with 200 pieces	55,50 €	11,10 €	20
	700E	BAP700E	Corner insert 60 x 40 mm	Bag with 200 pieces	56,00 €	11,20 €	20

To protect floors : Discover our gliding pads

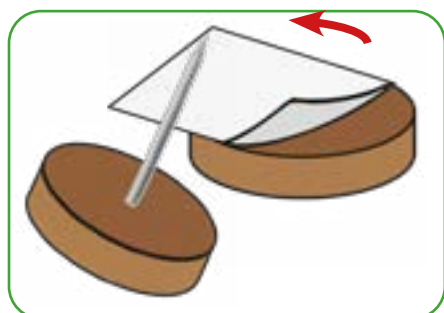

Selfstick or with screw or nail



High-density felt



For all floors

To find on page 11

**Furniture height adjustment
3 references for every use**

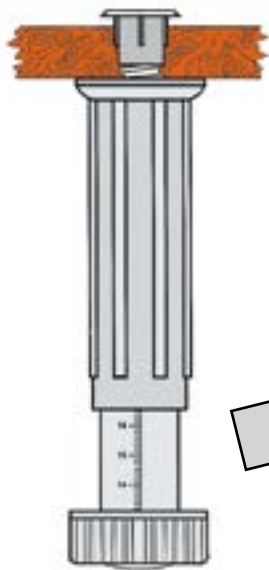

Furniture foot with dowel drilling
ø 13 mm (dowel provided)
Art. 4300
3 items available
adjustable from 100 to 190 mm

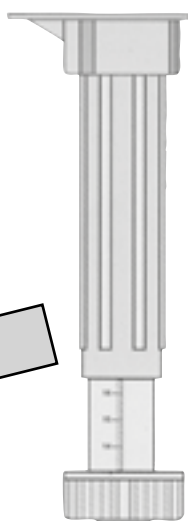

Furniture foot without advanced drilling
Fastening with 4 screws(provided)
Art. 4400
3 items available
adjustable from 100 to 200 mm

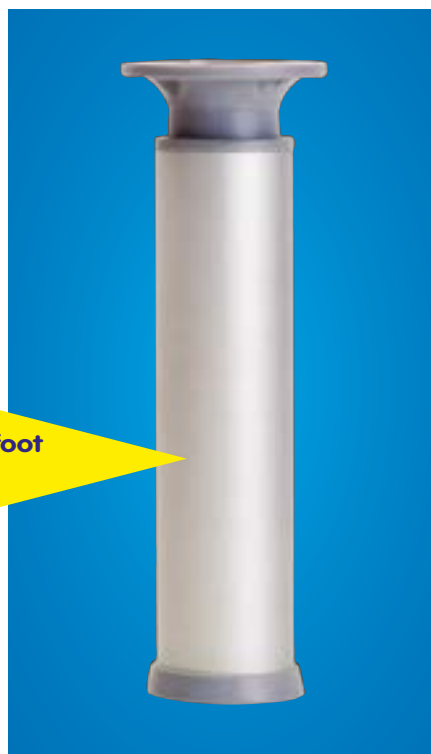

Furniture foot without advanced drilling
Fastening with 4 screws
3,5 x 16 mm (provided)
Art. 4100
Decorative foot in aluminium
for adjustment 30 mm

ø 46 mm

decorative foot
aluminium



Fitting clip (2 Clips for 4 feet)



Optional centring device which allows an optimal adjustment
and makes the installation of the plinth easier
screws 3,5 x 16 mm provided
Art. 4500

Art	Colour	Code	Designation	Packaging	100/€net	Box/€net	Qty.
4300	Black	PPVP100	Height adjustment foot 100 to 130 mm	Bag with 4 feet and 2 clips	122,50 €	4,90 €	4
		PPVS100		more than 20 bags	105,00 €	4,20 €	4
4330	Black	PPVP130	Height adjustment foot 130 to 160 mm	Bag with 4 feet and 2 clips	138,75 €	5,55 €	4
		PPVS130		more than 20 bags	121,25 €	4,85 €	4
4340	Black	PPVP140	Height adjustment foot 140 to 190 mm	Bag with 4 feet and 2 clips	147,50 €	5,90 €	4
		PPVS140		more than 20 bags	131,25 €	5,25 €	4
4400	Black	PAVP100	Height adjustment foot 100 to 140 mm	Bag with 4 feet and 2 clips	143,75 €	5,75 €	4
		PAVS100		more than 20 bags	127,50 €	5,10 €	4
4430	Black	PAVP130	Height adjustment foot 130 to 170 mm	Bag with 4 feet and 2 clips	148,75 €	5,95 €	4
		PAVS130		more than 20 bags	131,25 €	5,25 €	4
4440	Black	PAVP140	Height adjustment foot 130 to 200 mm	Bag with 4 feet and 2 clips	153,75 €	6,10 €	4
		PAVS140		more than 20 bags	138,75 €	5,55 €	4
4500	Black	CAVP300	Centring device for fitting clip	Bag with 10 clips	37,50 €	3,75 €	10
		CAVS300		more than 20 bags	30,00 €	3,00 €	10
4108	Black	PADP080	Alu foot adjustable 80 mm	Bag with 4 feet	1556,25 €	62,25 €	4
4110	Black	PADPI100	Alu foot adjustable 100 mm	Bag with 4 feet	1597,50 €	63,90 €	4
4112	Black	PADPI120	Alu foot adjustable 120 mm	Bag with 4 feet	1636,25 €	65,45 €	4
4114	Black	PADPI140	Alu foot adjustable 140 mm	Bag with 4 feet	1676,25 €	67,05 €	4
4116	Black	PADPI160	Alu foot adjustable 160 mm	Bag with 4 feet	1716,25 €	68,65 €	4
4118	Black	PADPI180	Alu foot adjustable 180 mm	Bag with 4 feet	1755,00 €	70,20 €	4



Retainer for windows and doors

TO FIX ON THE FRAME OF WINDOWS AND DOORS WHETHER WOODEN, ALU OR PVC



Fitting on a window 1 leaf



Fitting on a window 2 leaves



Fitting on a french window



VENTILBAIE creased



With children-security

EASY AND HANDY

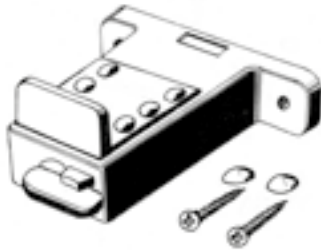

Art. CJS

LICENCE PRUNIER
100 x 100 x 26 mm
screws and caps inside

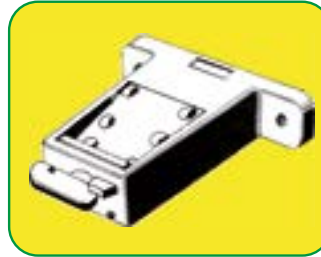

Lever on the left

The blocking-system is down :
The window leaf is free

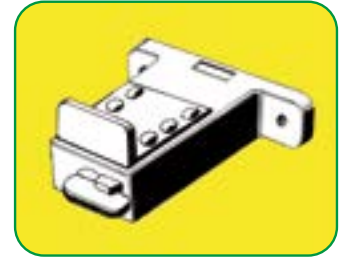

Lever on the right

The blocking system is up :
The window leaf is locked

VENTILBAIE is fixed above or below the level with the leaf

Art.	Colour	Code	Designation	Packaging	100/€net	Box/€net	Qty.
	CJS	VB*PCJS	Ventilbaie CJS	Sachet individuel	2500,00 €	25,00 €	1
		VB*ECJS	Ventilbaie CJS	Boîte de 10 pièces	2289,50 €	228,95 €	10

TACOPLAC



The revolutionizing fastener for all drywalls



- 1 Drill a 7 mm lead hole
- 2 Install the TACOPLAC with the hammer (pointer up)
- 3 Screw ø 4 mm
- 4 Fit it into the TACOPLAC.

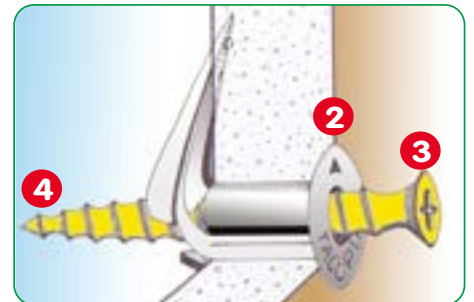

Art. 333

ø 17 mm x 36 mm



Display box
Art. 334



Art	Colour	Code	Designation	Packaging	100/€net	Box/€net	Qty.
	333	TK*P333	Anchor Tacoplac	Box with 50 pieces	37,80 €	18,90 €	50
		TK*S333	Anchor Tacoplac	40 boxes with each 50 pcs.	30,90 €	618,00 €	2000
		TK*E333	Anchor Tacoplac	Box with 250 pieces	27,90 €	69,75 €	250
		TK*M333	Anchor Tacoplac	20 boxes with each 250 pcs.	23,95 €	1197,50 €	5000
334		PRES334	Display box Tacoplac	Box 15 x 50 pcs (750 anchors)	*	186,60 €	1

44 Shelf support bracket 252



Shelf bracket

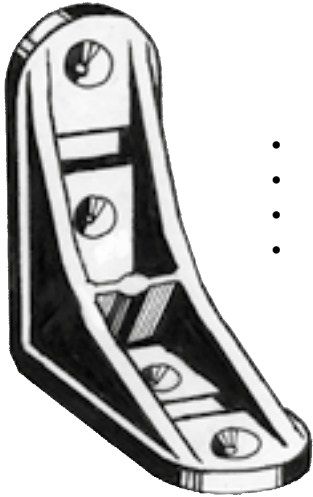

- INDISPENSABLE FOR**
- LIGHTWEIGHT STRUCTURES
 - LABORATORY FURNITURES
 - LINEAR SHELF BOARDS
 - WALL BOARDS

Art. 252

80 x 80 x 25 mm
4 holes for screws Ø 4 mm

4 colours available



Art.	Colour	Code	Designation	Packaging	100/€net	Box/€net	Qty.
252	Black	ST*P252	Console 4 trous	Boîte de 20 pièces	98,50 €	19,70 €	20
	Tan	ST*E252	Console 4 trous	Boîte ECO de 500 pièces	86,40 €	432,00 €	500

SYSTEMICAL TRANSPORT



Self-stick sponge for transport

Particularly useful for delicate transport (carpentries, Alu, PVC, windows, shutters etc ...)

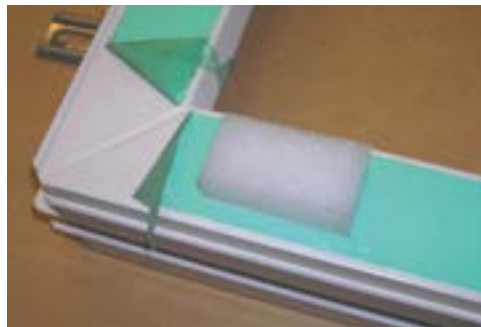

With special adhesive for a good posture, which don't leave traces on the glass, aluminium or PVC
RESISTANCE 3 Kg/cm² = DENSITY 40 %

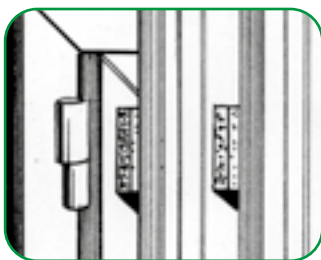

A little bumper to avoid big trouble

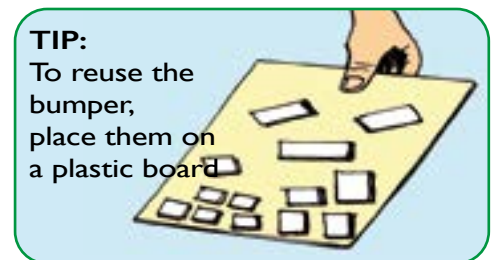
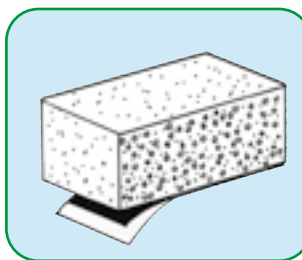

Art. 260
25 x 25 x 10 mm



Art. 270
50 x 25 x 15 mm



Art. 280
50 x 30 x 10 mm



Art. 290
50 x 30 x 20 mm

Art.	Colour	Code	Designation	Packaging	100/€net	Box/€net	Qty.
260	Black	SMPP260	Bumper 25 x 25 x10 mm	Box with 322 pieces	11,91 €	38,35 €	322
	White	SMPE261	Bumper 25 x 25 x10 mm	Box ECO with 9660 pieces	8,21 €	821,41 €	10005
270	Black	SMPP270	Bumper 50 x 25 x15 mm	Box with 495 pieces	14,69 €	72,72 €	495
	White	SMPE271	Bumper 50 x 25 x15 mm	Box ECO with 2970 pieces	14,16 €	420,55 €	2970
280	White	SMPE280	Bumper 50 x 30 x 10 mm	Box ECO with 3696 pieces	19,16 €	708,15 €	3696
290	White	SMPE290	Bumper 50 x 30 x 20 mm	Box ECO with 1848 pieces	23,32 €	430,95 €	1848

Pull-down wardrobe lift



Wardrobe lift

Art. 1082 600 mm - 830 mm
 Art. 1083 830 mm- 1150 mm
 Capacity 12 kilos



Pull-out pants holder

Alu/foam
 Width 360 mm Depth 460 mm
 Art. 3200 (right)
 Art. 3201 (left)



Pull-out valet rod
 Chromed steel and aluminum

Art. 3300
 L 100 mm P 350 mm H 130 mm



Pull-out tie holder
 Aluminium and plastic tone alu

Art. 3350
 L 65 mm P 450 mm H 81 mm

Art.	Colour	Code	Designation	Packaging	Box/€ net	Qty.
1082		EVPI082	Wardrobe lift small	Individual	110,55 €	1
1083		EVPI083	Wardrobe lift , big	Individual	111,95 €	1
3200		PPD3200	Pants holder right	Individual	100,75 €	1
3201		PPG3201	Pants holder left	Individual	100,75 €	1
3300		PCP3300	Valet rod	Individual	102,00 €	1
3350		PCP3350	Tie holder	Individual	31,95 €	1

PLASTIHANDLES

The plastic handle which has nothing to hide

Aluminium finishing - Anti UV protection - High resistance



	Art.	Colour	Code	Designation	Packaging	100/€ net	Box/€ net	Qty.
	MESTRE		APMS064	Handle Mestre 64 mm	Bag with 1 handle + 2 screws	155,00 €	1,55 €	1
	RIDANA		APRI160	Handle Ridana 160 mm	Bag with 1 handle + 2 screws	205,00 €	2,05 €	1
	PORTO		APPO192	Handle Porto 192 mm	Bag with 1 handle + 2 screws	285,00 €	2,85 €	1
	PARTENON		APPA128	Handle Partenon128 mm	Bag with 1 handle + 2 screws	195,00 €	1,95 €	1
			APPA160	Handle Partenon160 mm	Bag with 1 handle + 2 screws	215,00 €	2,15 €	1
	MECA		APME160	Handle Meca 160 mm	Bag with 1 handle + 2 screws	220,00 €	2,20 €	1
			APME192	Handle Meca 192 mm	Bag with 1 handle + 2 screws	370,00 €	3,70 €	1
			APME256	Handle Meca 256 mm	Bag with 1 handle + 2 screws	620,00 €	6,20 €	1
	BELLARIA		APBE160	Handle Bellaria 160 mm	Bag with 1 handle + 2 screws	240,00 €	2,40 €	1
			APBE224	Handle Bellaria 224 mm	Bag with 1 handle + 2 screws	360,00 €	3,60 €	1
	CAROLINA		APCA032	Handle Carolina 32 mm	Bag with 1 handle + 2 screws	150,00 €	1,50 €	1
	AVILA		APAV032	Handle Avila 32 mm	Bag with 1 handle + 2 screws	145,00 €	1,45 €	1

Clothes rail and holder

Holder



Art. 125
screw hole \varnothing 4 mm
50 x 20 x 15 mm



Art. 129
screw hole \varnothing 4 mm
80 x 40 x 15 mm

Oval tube



2 m long

Art. 127
white lacquered
or chromed

Art. 128
brassed
30 x 15 mm



Art	Colour	Code	Designation	Packaging	100/€net	Box/€net	Qty.
125		ST*P125	Holder	Bag with 20 pieces	24,50 €	4,90 €	20
		ST*E125	Holder	Box ECO with 200 pieces	17,20 €	34,40 €	200
127		TR*P127	Chlothes rail	Box with 10 tubes	1081,00 €	108,10 €	10
128		TR*P128	Chlothes rail	Box with 10 tubes	1474,50 €	147,45 €	10
129		ST*P129	Central holder	Box with 10 pieces	275,50 €	27,55 €	10

PUSH-PULL

Opening-closing-system without handle

Push on the door to engage the opening.
Fitting also on the drawer possible.

ECONOMIC
No more handles on doors and drawers

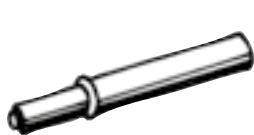

Art. 682
53 x \varnothing 12 mm
hole \varnothing 10 mm



Art. 684
80 x \varnothing 12 mm
hole \varnothing 10 mm



Art. 692
62 x 20 x 14,5 mm
screw hole \varnothing 3 mm



Art. 792
90 x 20 x 14,5 mm
screw hole \varnothing 3 mm

Art	Colour	Code	Designation	Packaging	100/€net	Box/€net	Qty.
682		PL*P682	Push-pull to fit flash 53 x \varnothing 12 mm	Bag with 10 pieces	501,50 €	50,15 €	10
		PL*E682		Box with 100 pieces	462,70 €	462,70 €	100
684		PL*P684	Push-pull to fit flash 80 x \varnothing 12 mm	Bag with 10 pieces	528,50 €	52,85 €	10
		PL*E684		Box with 100 pieces	489,10 €	489,10 €	100
692		PL*P692	Push-pull to screw 62 x 20 x 14,5 mm	Bag with 10 pieces	595,00 €	59,50 €	10
		PL*E692		Box with 100 pieces	555,20 €	555,20 €	100
792		PL*P792	Push-pull to screw 90 x 20 x 14,5 mm	Bag with 10 pieces	621,50 €	62,15 €	10
		PL*E792		Box with 100 pieces	581,65 €	581,65 €	100

For the blockage of all openings



Possible to block the door or hatch in opened or closed position

Art. 608
 Male: for 2 screws \varnothing 3 mm 45 x 28 x 11 mm
 Female: for screw \varnothing 4-5 mm, \varnothing 30 x 25 mm



Art.	Colour	Code	Designation	Packaging	100/€net	Bag/€net	Qty.
608		SP*P608	Stoporte	Bag with 25 pieces	78,80 €	19,70 €	25



CALPORTES

Sawtooth wedges : to block the doors

Our ribbed wedges are used as door blocking for years. In order to better meet this usage, we have compiled a selection in an assortment called CALPORTE

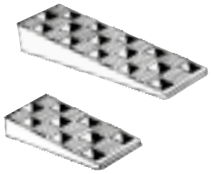

Art. 1525
 Assortment CALPORTES *
 5 wedges 45 x 15 mm and
 5 wedges 45 x 25 mm



Art.	Colour	Code	Designation	Packaging	100/€net	Bag/€net	Qty.
1525		ACSI525	Assortment (2x5)	Bag with 10 pieces	*	11,80 €	1
		ACXI525	Assortment (2x5)	more than 10 bags (price 1 bag)	*	10,65 €	1



BLOCPORTE

Double function: stops and blocks the door

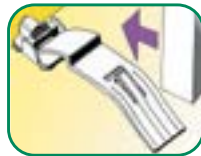

Art. 640
 210 x 41 x 44 mm

For doors until 45 mm thickness,
 7 to 40 mm leave
 thanks our exclusive regulation process

Art.	Colour	Code	Designation	Packaging	100/€net	Bag/€net	Qty.
640		FP*P640	Door blocker	Individual bag	975,00 €	9,75 €	1
		FP*S640	Door blocker	more than 20 bags (price 1 bag)	845,00 €	8,45 €	1

STOPTAC

Self-stick door bumper

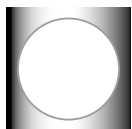

Chrome - white
BCBP607

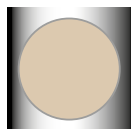

Chrome - beige
BCIP607

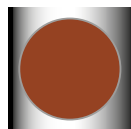

Chrom - brown
BCMP607

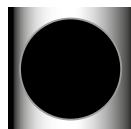

Chrome - black
BCNP607

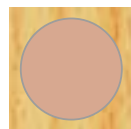

Pine - camel
BPCP607



Teak - brown
BTMP607

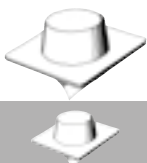

STOPTAC Art. 607
 Dimensions: 45 x 45 \varnothing 35 x 19 mm

Can be sticked or screwed

Art.	Colour	Code	Designation	Packaging	100/€net	Box/€net	Qty.
607	Colours see here above		Door blocker 45 x 45 mm	Box with 25 pieces	191,20 €	47,80 €	25

Door wedge device with locking lever

Holds the door wherever you want.



SYSTEMCAL porte is especially recommended

- ⇒ in the HOUSEHOLD to maintain the door open without fear of drafts.
- ⇒ dans HOTEL INDUSTRY for the daily cleaning of the rooms.
- ⇒ in OFFICES and WORKSHOPS.
- ⇒ for cleaning firms, moving companies and renovation.
- ⇒ pour les public services (schools, hospitals, care homes)

This system was designed to be operated with the tip of the foot.

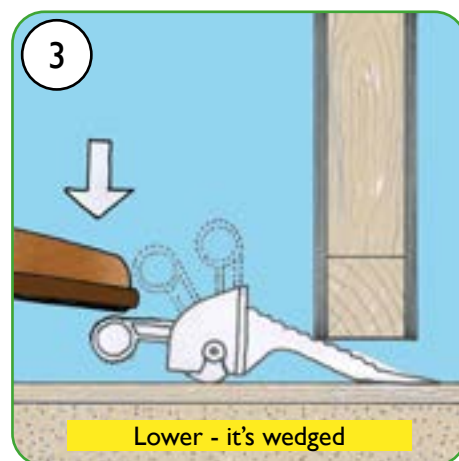
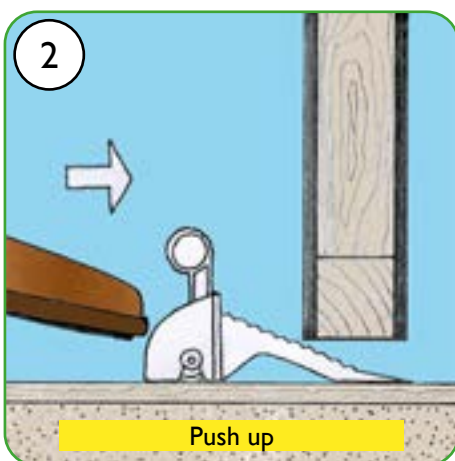
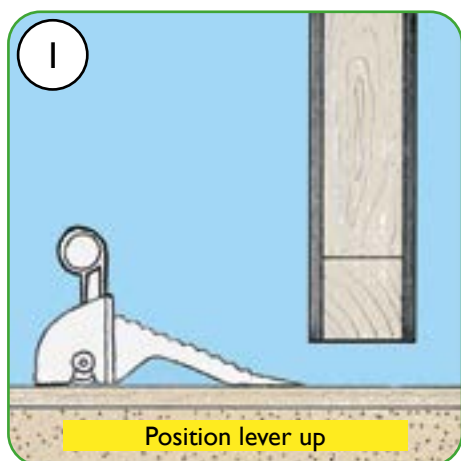

Our new SYSTEMCAL-door is very easy to use.

It's enough to position the wedge in the door clearance and lower the lever to secure it.

Possible with door clearance from 10 mm minimum to 33 mm maximum.

NEW

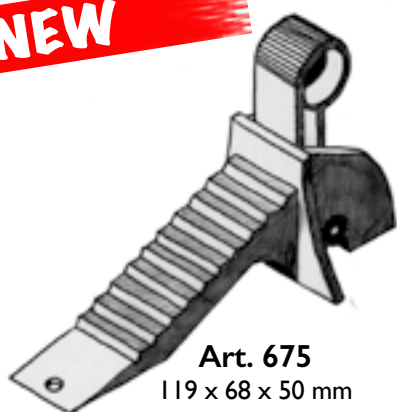

Art. 675
119 x 68 x 50 mm

Made of ABS



Art.	Colour	Code	Designation	Packaging	100/€net	Box/€net	Qty.
675		SPGP675	Systemcal door	Bag with 2 pieces and notice	682,50 €	13,65 €	2
		SPGE675	Systemcal door	Box ECO 20 pieces	606,00 €	121,20 €	20

CUSTOM PACKAGING

Personalized packaging with your brand

Packaging is becoming more important. It communicates the unique identity of the products or brands in the market.

With a customized packaging, you will influence the customer's first impression of your business and and create brand recognition.



Some of our products in printed bags could be personalized with your logo and a individual description for your customers.



Put your image to your products to attract and retain your customers

FREE

HERE YOUR BRAND !



HERE YOUR DESCRIPTION !

more than 500 bags



HERE YOUR BRAND

more than 40 boxes

TOOL SYSTEM

Passé system, Silnet, Multitasking shovel



Perfect to try our tools (details tools page 2 and 10)



Art. 1527 Assortment 5 tools *
 1 yellow shovel, 1 black shovel 1 red Silnet, 1 blue Silnet, 1 Passe System

Art.	Colour	Code	Designation	Packaging		Box/€net	Qty.
1527		AMS1527	Assortment 5 tools	Box with 5 pieces	*	49,15 €	1
		AMX1527	Assortment 5 tools	More than 5 boxes	*	43,10 €	1

GENERAL CONDITION OF SALE

1 • Following conditions for delivery and payment are valid and accepted by the purchaser as legally binding with placing the order.

2 • ORDER :

To avoid any mistake we ask to specify each article with its code number and eventually the colour appearing in this catalogue. We don't send order confirmation.

3 • DELIVERY :

The merchandise is delivered in any case on the purchaser's risk, even for transactions free of charge. We ask the consignee to sign a transport insurance to be covered in case of damage or loss. For abroad deliveries our prices are ex works, packing included

4 • INVOICE :

The minimum order value per delivery is 20,00 Euros ex VAT, discount performed. For orders below this amount a small charge of 3,00 Euros will be added. All invoices are made the current price on the day of delivery.

5 • TERMS OF PAYMENT :

Unless expressly agreed to differently, our invoices are payable within 30 days after delivery. By exceeding the maturity interest for default on the current bank-rate will be added without any foregoing reminder.

6 • JURISDICTION :

Place of performance and legal venue for both parties is Toulouse. Property reserve according to law N° 880335 of May 12th, 1980.

7 • This price list replaces all other previous lists.



**3, avenue Louis Blériot - Z.A. Val de Saune -
31570 Sainte Foy d'Aigrefeuille - FRANCE
TEL: 05 61 83 06 55 - FAX: 05 61 83 56 03
email : info@prunier-sp.com**



www.prunier-sp.com